



ASSEMBLY INSTRUCTION

ITEM : AVALON , CHEST OF DRAWER

HARDWARE LIST

ITEM	DESCRIPTION	QTY
A	SCREW M4 X 16 mm 	16 pcs
B	ALLEN KEY M4 	1 pc

CAUTIONS :
Hardware are to kept out of reach from children.

PART LIST

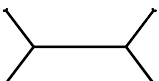
PART	DESCRIPTION	QTY
LEG		4 pcs
LEG FRAME		1 pc

STEP 1

Attach " LEG FRAME " to the " LEG " as arrow shown , assembly by using " ALLEN KEY ".
(DO NOT FULLY TIGHTEN THE SCREW UNTIL ALL ARE IN PLACE)

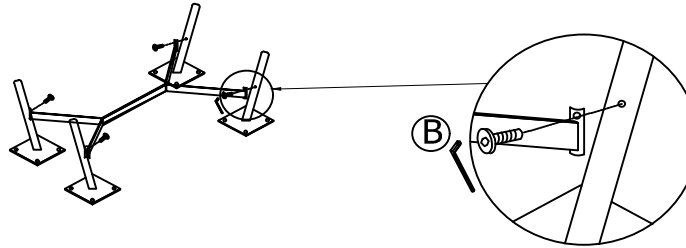

STEP 2

Attach " LEG " to the " BODY " as arrow shown , assembly with hardware " A " by using " screw driver ". (NOT INCLUDE). (DO NOT FULLY TIGHTEN THE SCREW UNTIL ALL IN PALCE)

STEP 3

Attach hardware "ANTI TIPPING" to the wallboard and furniture frame under the top with screw provided.

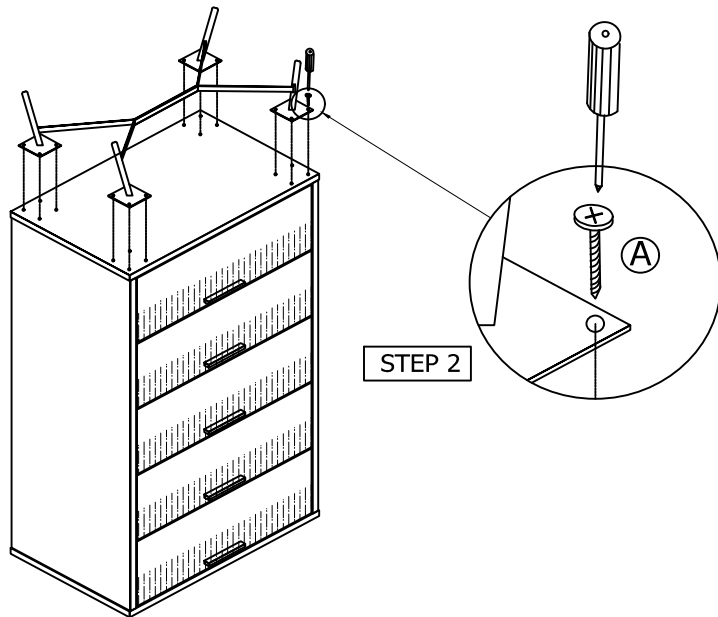

STEP 2

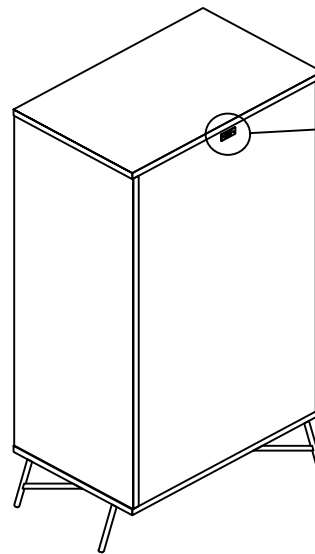

STEP 3

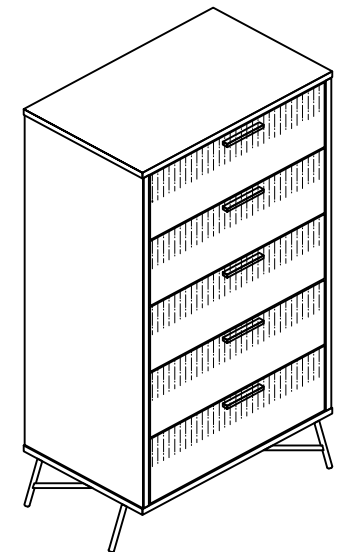

STEP 4

COMPLETE ASSEMBLY.

NOTE
a) BEFORE ASSEMBLY, PLACE ALL TABLE PARTS ON THE CLEAN AND SOFT SURFACE TO PREVENT SCRATCHEDS.
b) THIS PRODUCT IS HEAVY , FOR SAFETY PURPOSE , KINDLY ADVISE 2 OR MORE PEOPLE TO ASSEMBLY.

MADE IN MALAYSIA