

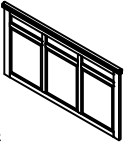

# WINNERS ONLY®



## ASSEMBLY INSTRUCTIONS

PROD NO.: BMG1001CKH/BMG1001CKHS/BMG1001KH/BMG1001KHS

### Component List :

<b>(A)</b> Headboard Panel  1pc	<b>(B)</b> Headboard Legs L & R  2pcs
---	---

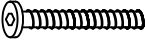
### Hardware List :

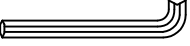
<b>(1)</b> Long JCBC Bolt $\phi 5/16"$ x L44mm  8pcs	<b>(2)</b> Spring Washer 5/16"(Φ12)*2mm  8pcs	<b>(3)</b> Flat Washer 5/16"(Φ19)*2mm  8pcs	<b>(4)</b> Allen Key 4*59mm  1pc
--	---	---	--

**Caution:** Please read instructions thoroughly before unpacking assembly parts. Sharp, exposed staple tips can cause injury, therefore, for your protection, please remove any exposed staples used in packing.

*Please keep all hardware parts out of the reach of children.*

1. We recommend that you should assemble this product with the assistance of another person; this will make assembly easier, and will help to eliminate damage to the product or injury to persons during assembly.
2. Be sure to check all packing materials carefully for small parts that may have come loose inside the carton during shipment.
3. Please do not over tighten screws or bolts.
4. Please put all parts on a non-abrasive floor before assembly, and follow the assembly steps to assemble your newly purchased product correctly and efficiently.

Note : Bunkie board must be used to replace box spring

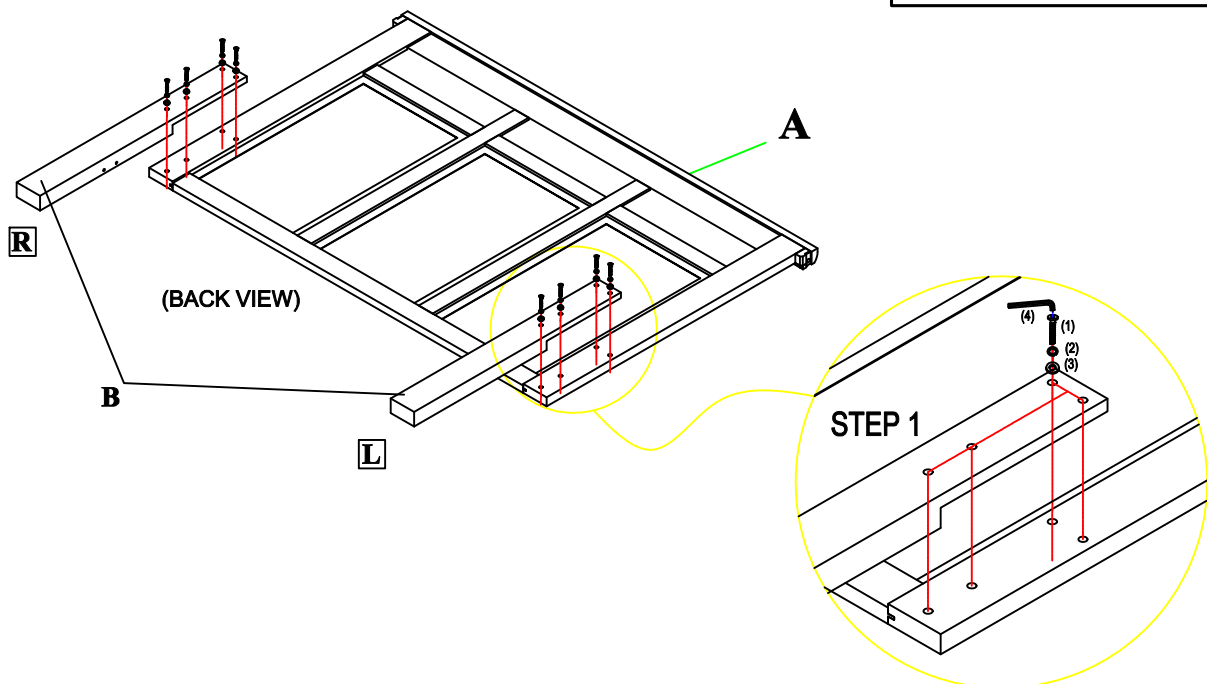
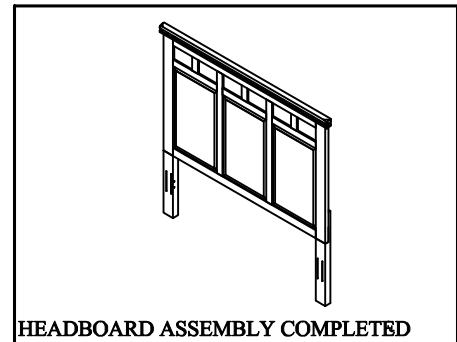



# WINNERS ONLY®

## ASSEMBLY INSTRUCTIONS

PROD NO.: **BMG1001CKHS / BMG1001KHS / BMG1001CKFS**  
**BMG1001KFS / BMG1001KRS / BMG1001CKRS**

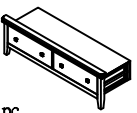
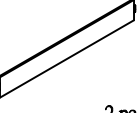
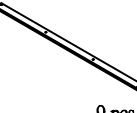
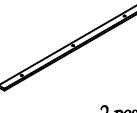

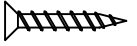

### Component List KING :

<b>(A) Headboard</b>  1pc	<b>(B) Footboard</b>  1pc	<b>(C) Side Rails</b>  2 pcs	<b>(D) Slats</b>  9 pcs	<b>(E) Slats Support Legs</b>  2 pcs	<b>(F) Slat Support Legs</b>  6 pcs
---	--	---	--	---	--

### Hardware List KING :

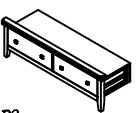
<b>(1) Screw #8*25mm</b>  44 pcs
---

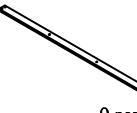
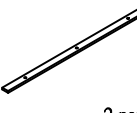
### Component List CAL.KING:

<b>(A) Headboard</b>  1pc	<b>(B) Footboard</b>  1pc	<b>(C) Side Rail Left</b>  1pc	<b>(D) Side Rail Right</b>  1pc	<b>(E) Slats</b>  9 pcs	<b>(F) Slats Support Legs</b>  2 pcs	<b>(G) Slat Support Legs</b>  6 pcs
---	--	---	--	--	--	--

### Hardware List CAL.KING :

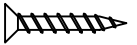
<b>(1) Screw #8*25mm</b>  44 pcs
---

**Caution:** Please read instructions thoroughly before unpacking assembly parts. Sharp, exposed staple tips can cause injury, therefore, for your protection, please remove any exposed staples used in packing.

*Please keep all hardware parts out of the reach of children.*

1. We recommend that you should assemble this product with the assistance of another person; this will make assembly easier, and will help to eliminate damage to the product or injury to persons during assembly.
2. Be sure to check all packing materials carefully for small parts that may have come loose inside the carton during shipment.
3. Please do not over tighten screws or bolts.
4. Please put all parts on a non-abrasive floor before assembly, and follow the assembly steps to assemble your newly purchased product correctly and efficiently.

