

WINNERS ONLY®









ASSEMBLY INSTRUCTIONS







PROD.NO : BTB/BTG/BTH/BTP1001F
 PROD.NO : BTG/BTH/BTP1001Q

Caution: Please read instructions thoroughly before unpacking assembly parts. Sharp, exposed staple tips can cause injury. Therefore, for your protection, please remove any exposed staples used in packing.

Please keep all hardware parts out of the reach of children.

1. We recommend that you should assemble this product with the assistance of another person; this will make assembly easier and will help to eliminate damage to the product or injury to persons during assembly.
2. Be sure to check all packing materials carefully for small parts that may have come loose inside the carton during shipment.
3. Please do not over tighten screws or bolts.
4. Please put all parts on a non-abrasive floor before assembly, and follow the assembly steps to assemble your newly purchased product correctly and efficiently.

| Components List : | | | |
|-------------------|----------------|-------|---|
| NO. | DESCRIPTION | Q' TY | |
| A | HB Right Leg | 1pc |  |
| B | HB Left Leg | 1pc |  |
| C | Headboard | 1pc |  |
| D | Wood stretcher | 1pc |  |
| E | Footboard | 1pc |  |
| F | Side rail | 2pcs |  |
| G | Slat | 4pcs |  |
| H | Support Leg | 4pcs |  |

| Hardware List | | | | |
|---------------|------------------|---------------|---|-------|
| NO. | DESCRIPTION | SIZE | SKETCH | Q' TY |
| 1 | Flat Washer | 8*19*2mm |  | 8pcs |
| 2 | Spring Washer | 8mm |  | 16pcs |
| 3 | Allen Bolts | 1/4"*1-9/16" |  | 2pcs |
| 4 | Allen Bolts | 5/16"*1-9/16" |  | 6pcs |
| 5 | Allen Key | 4*30*80mm |  | 1pc |
| 6 | Allen bolt | 5/16" * 3" |  | 8pcs |
| 7 | Half moon washer | Ø5/16" |  | 8pcs |
| 8 | Hex Nut | Ø5/16"*12mm |  | 8pcs |
| 9 | Wrench | 12mm |  | 1pc |
| 10 | Wood Screw | #8*1-1/4" |  | 8pcs |

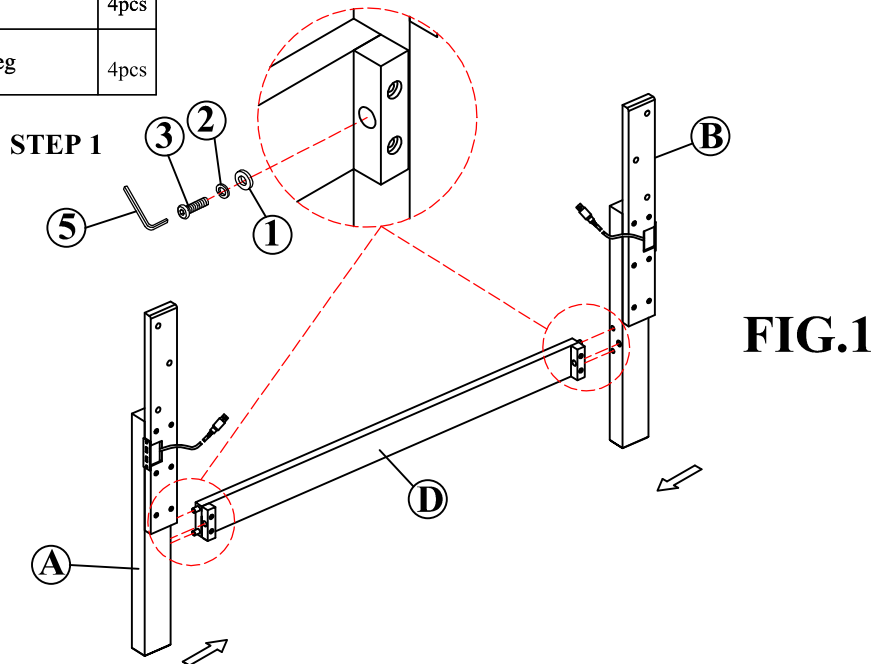

STEP 1: Attach the Wood Stretcher (D) to both Headboard Legs (A&B) using provided hardware as shown on FIG.1

WINNERS ONLY[®]

ASSEMBLY INSTRUCTIONS

PROD.NO : BTB/BTG/BTH/BTP1001F
PROD.NO : BTG/BTH/BTP1001Q

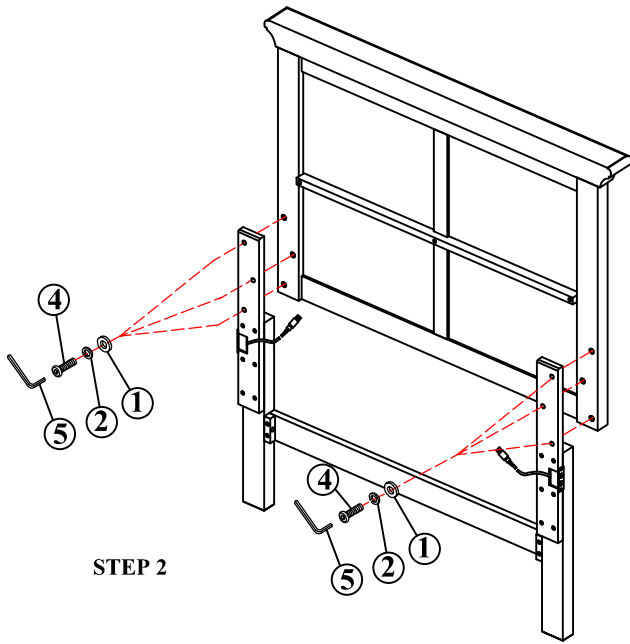

STEP 2: Attach the Headboard (C) to the Legs assembly (A,B&D) using provided hardware as shown on FIG.2

FIG.2

STEP 2

STEP 3: Attach both Bed Rails (F) to the Headboard assembly (A,B,D&C) using the provided hardware as shown on FIG.3

STEP 3: Attach both Bed Rails (F) to the Footboard (E) using the provided hardware as shown on FIG.4

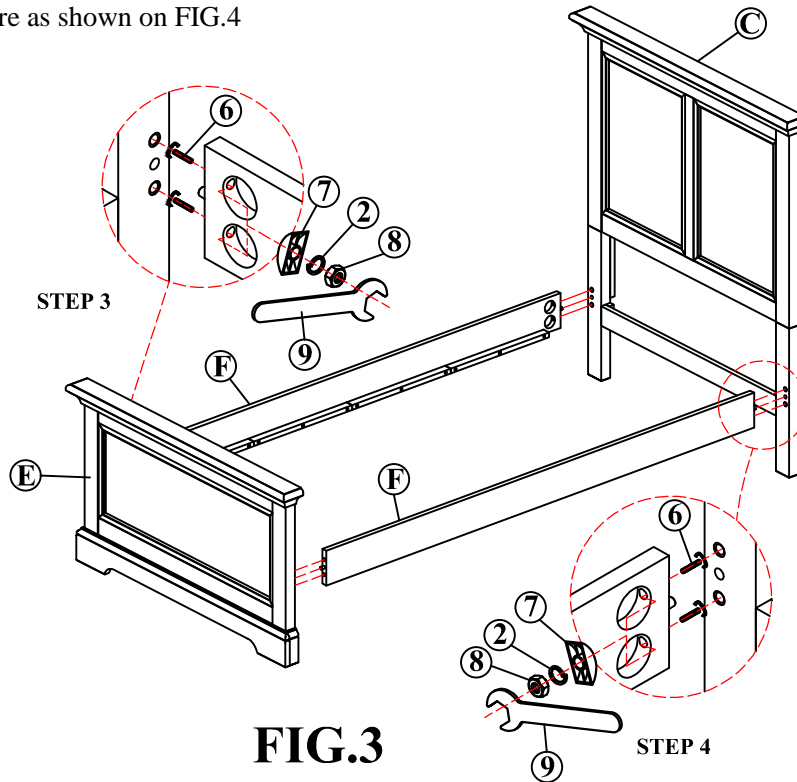

FIG.4

FIG.3

STEP 4

WINNERS ONLY®

ASSEMBLY INSTRUCTIONS

PROD.NO : BTB/BTG/BTH/BTP1001F
PROD.NO : BTG/BTH/BTP1001Q

STEP 5: Attach Support Legs (H) to Slats (G) as shown on FIG.5.
STEP 6: Attach Slats with Support legs (G&H) to the Side Rail (F) using the provided hardware as shown on FIG.6

FIG.5

STEP 5

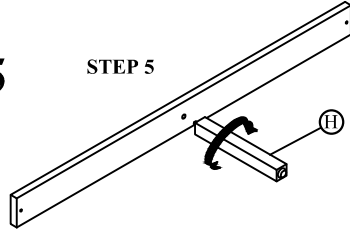

STEP 6

FIG.6

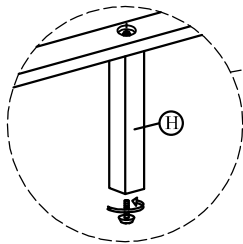
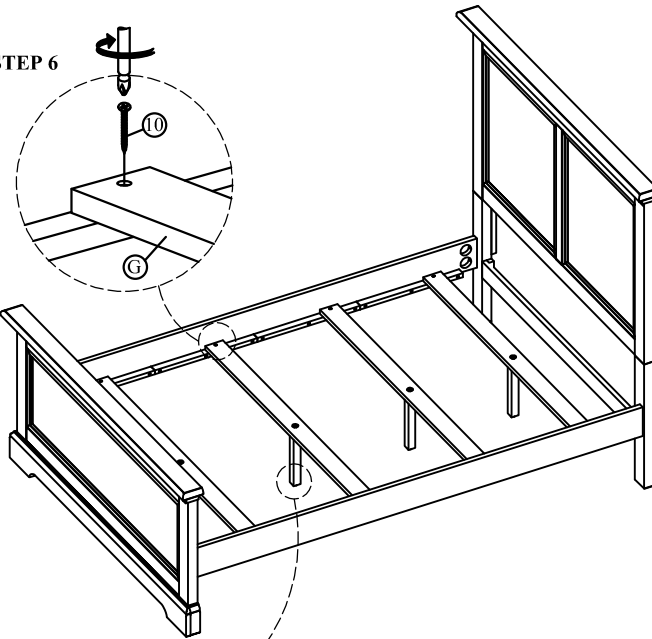

Assembly is now completed.

