

ASSEMBLY INSTRUCTION FOR C1-MM012S

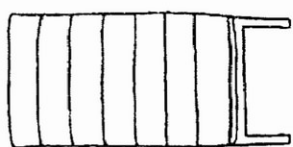

A 1pc

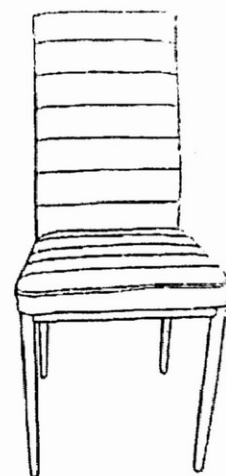
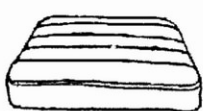

B 1pc

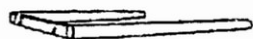

C 1pc

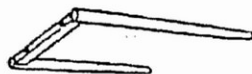

D 1pc

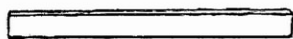

E 1pc

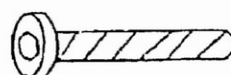

F 2pcs



G 4pcs

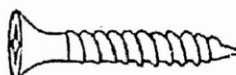

H 4pcs

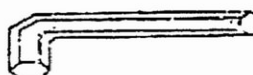

I 1pc



J 4pcs

①

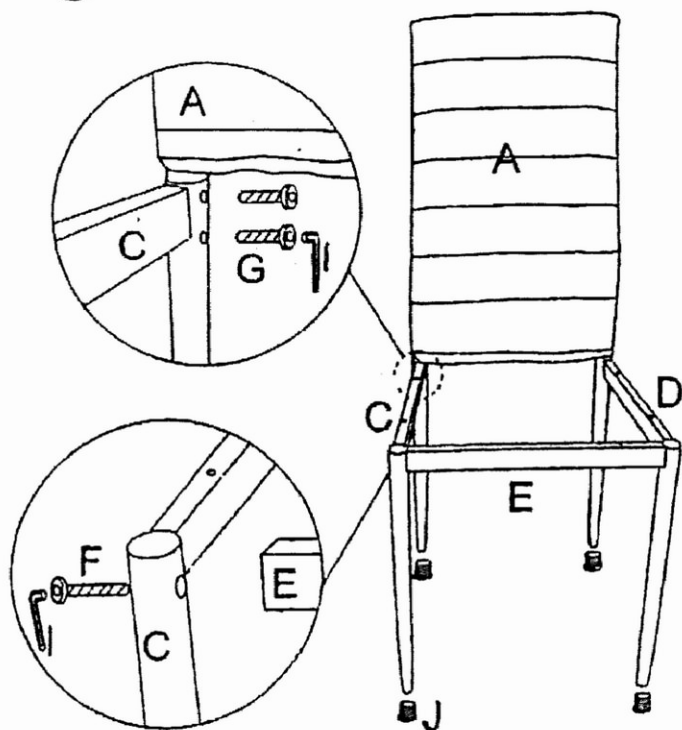

②

