

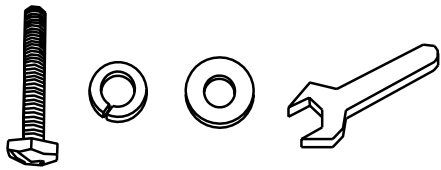

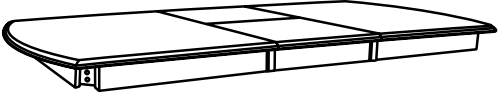





Assembly Instructions

T1-ES4278N-X

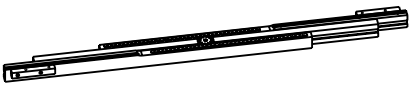
SOLID TOP RECTANGULAR BUTTERFLY EXTENSION DINING TABLE

PARTS LIST

PART NO	FIGURE	DESCRIPTION	Q'TY
T1-SF4278-01		Hardware Bag	1 Pc
T1-SF4278-13		Table Top	1 Pc
T1-SF4278-07		Leg	4 Pcs
T1-SF4278-02		Apron Hinge	4 Pcs
T1-SF4278-09		Leaf Hinge	3 Pcs
T1-SF4278-05		Glides	2 Pcs
T1-SF4278-10		Table Hook	4 Pcs
T1-SF4278-12		Support Leaf Hinge	2 Pcs
T1-SF4278-20		Apron Leaf	2 Pcs

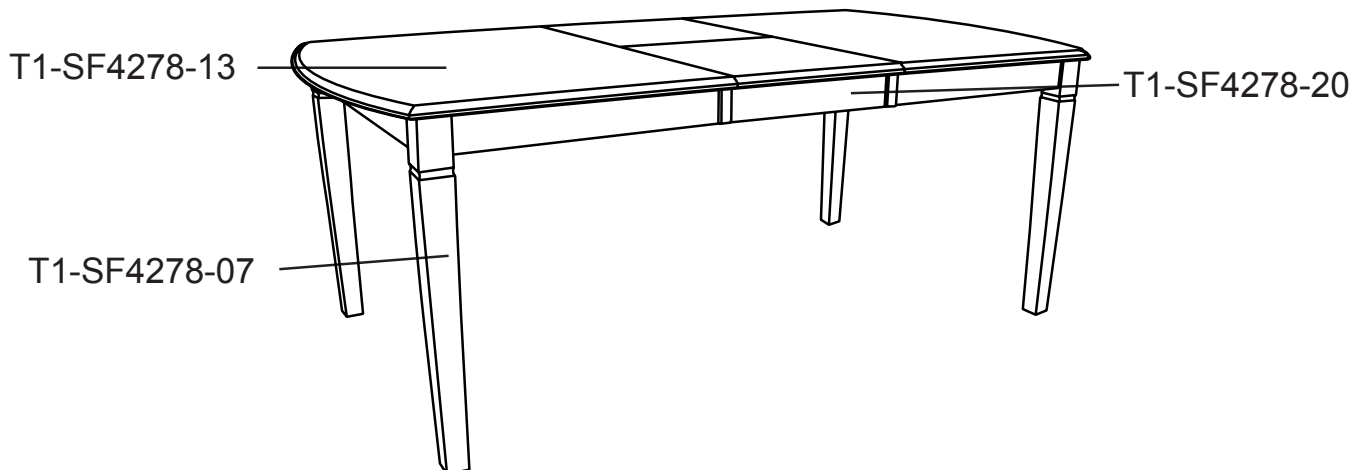



Assembly Instructions

T1-ES4278N-X

SOLID TOP RECTANGULAR BUTTERFLY EXTENSION DINING TABLE

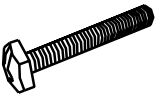
HARDWARE PARTS :

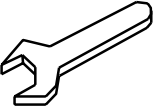
			
Hex Bolt 8 pcs	Lock Washer 8 pcs	Flat Washer 8 pcs	Wrench 1 pc

NOTE: THE UNIT SHOULD BE ASSEMBLED BY 2 OR MORE PEOPLE.

ASSEMBLY :

- 1) Turn the Table Top upside down on a protective surface such as carpet or other soft material. Place the leg to corner of Apron, then tighten the **Flat Washer, Lock Washer** and **Hex Bolt** using the **Wrench** provided. Repeat the same for the other legs. Set the Table upright on its legs.

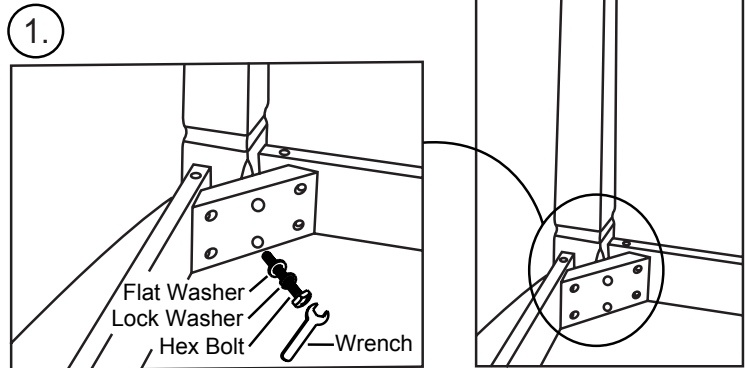

- 2) Unlock the hook underneath the table and pull the table top wide open equally from both ends. Lift both leaves from the compartment.
- 3) Flip up the aprons and unfold leaf and place the leaf on the Table Top surface carefully.
- 4) Push table top from both ends to close. Lock the hook underneath the table.

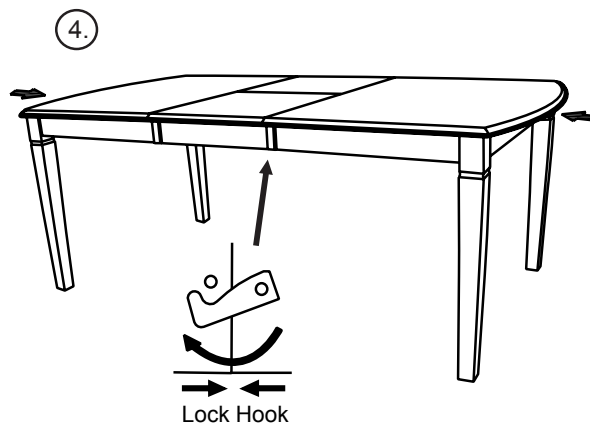
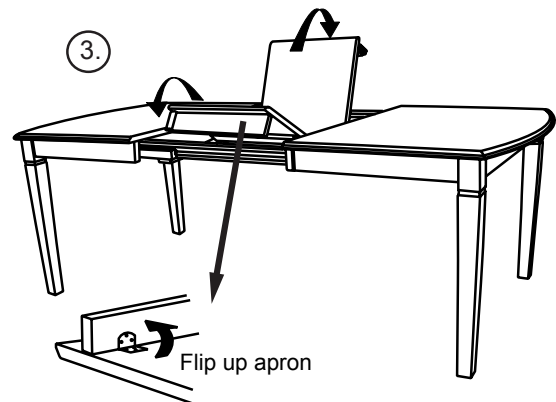
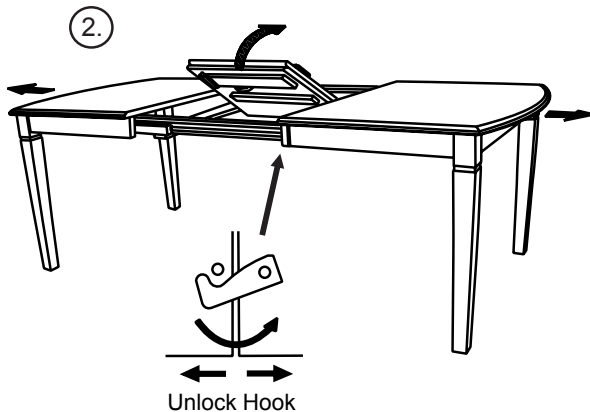

CARE INSTRUCTION

- ~ Be sure to use the same type of polish consistently. Your furniture will appear cloudy or streaky if oil based or wax based polishes are interchanged.
- ~ Spray your furniture surface evenly. Wipe in a circular motion with a soft clean cloth.