

WINNERS ONLY®

Assembly Instruction

T1-GV4866N-G



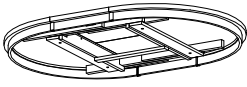

Caution: Please read instructions thoroughly before unpacking assembly parts. Sharp, exposed staple tips can cause injury, therefore, for your protection, please remove any exposed staples used in packing. Please keep all hardware parts out of the reach of children.

- 1) We recommend that you should assemble this product with the assistance of another person; this will make assembly easier, and will help to eliminate damage to the product or injury to person during assembly.
- 2) Be sure to check all packing materials carefully for small parts that may have come loose inside the carton during shipment.
- 3) Please do not over tighten screws or bolts.
- 4) Please put all parts on a non-abrasive floor before assembly, and follow the assembly steps to assemble your newly purchased product correctly and efficiently.

TOP COMPONENTS

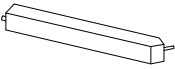
PART NO	FIGURE	DESCRIPTION	Q'TY
DFG14866T - 02		Table Top	1 Pc

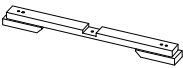
BASE COMPONENTS

PART NO	FIGURE	DESCRIPTION	Q'TY
DFG14866B - 01		Hardware Bag	1 Pc
DFG14866B - 03		Leg (Top)	4 Pcs
DFG14866B - 04		Leg Block	1 Pc
DFG14866B - 05		Leg (Bottom)	4 Pcs
DFG14866B - 06		Flat Leg 1	1 Pc
		Flat Leg 2	1 Pc

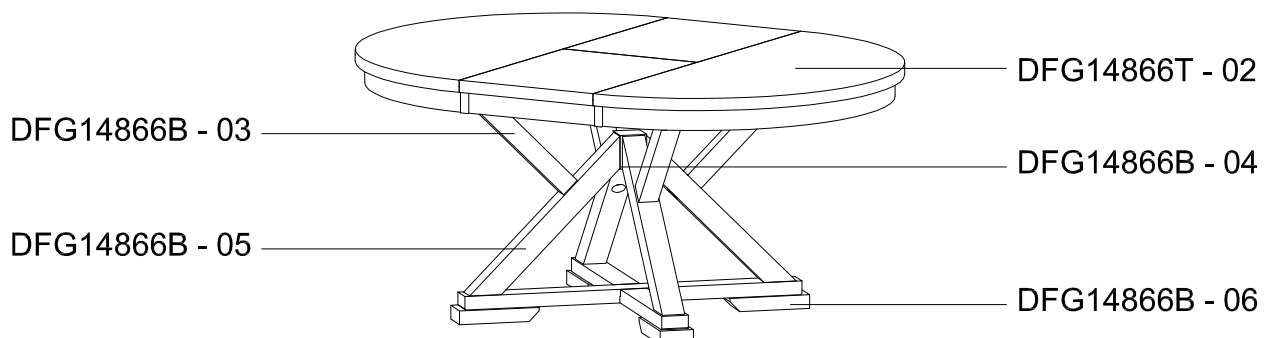







WINNERS ONLY®

IMPORTANT NOTICE:
Storing and opening the leaf
requires 2 people.

Assembly Instruction

DFG14866

HARDWARE PARTS :

						
Hex 102mm 4 pcs	Hex 76mm 4 pcs	Hex 38mm 5 pcs	Nut 4 pcs	Lock Washer 17 pcs	Flat Washer 17 pcs	Wrench 1 pc

NOTE : THE UNIT SHOULD BE ASSEMBLED BY 2 OR MORE PEOPLE.

ASSEMBLY

- 1) Attached the Bottom Legs to the Leg Block using the provided hardware as shown on Fig. 1.
- 2) Attached Flat Leg 1 and Flat Leg 2 to each using the provided hardware as shown on Fig. 2.
- 3) Attached the Flat Leg assembly to the Bottom leg assembly using the provided hardware as shown on Fig. 3.
- 4) Attached the Top Legs to Bottom Legs using the provided hardware as shown on Fig. 4.
- 5) Attached table top to the fully assemble base using the provide hardware as shown on Fig. 5.
- 6) Assembly is now complete.

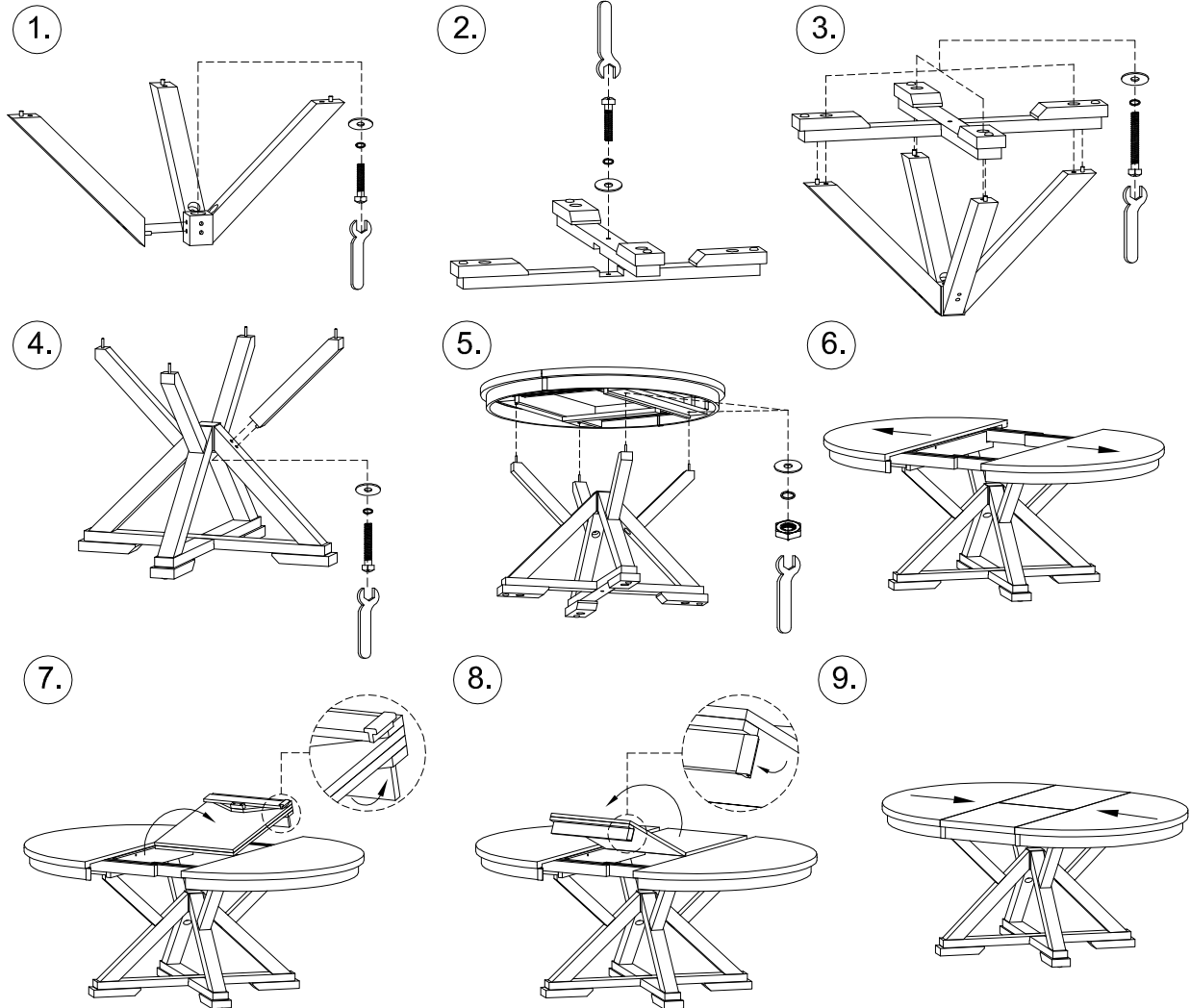

Opening Table Leaf Instructions

- 1) Unlock table Locks (underneath the table).
- 2) Pull table top from both ends.
- 3) Lift Leaf from storing leaf compartment.
- 4) Open Leaf Apron.
- 5) Push table top from both ends and lock the table locks.