







### Hardware List

1		1/4"x1-1/4" Machine Bolts	16 PCS	2		7/8" Sharp end screws	28 PCS
3		Shelf Clips	16 PCS	4		3/4" Sharp end screws	16 PCS
5		Connection plate	1 PCS	6		1/2" Round flat-head screws	2 PCS
7		5/8" Sharp end screws	12 PCS				

### Parts List

A	TOP	1 PC	B	Right Side Panel	1 PC	C	Left Side Panel	1 PC
								
D	Fixed Shelf	1 PC	E	Bottom Panel	1 PC	F	Back Panel	1 PC
								
G	Adjustable shelves	4 PCS	H	DOOR	2 PCS			
								

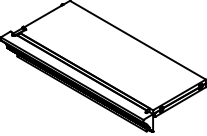
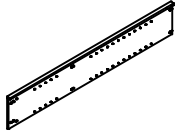
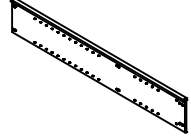
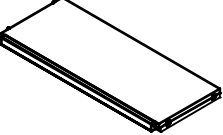
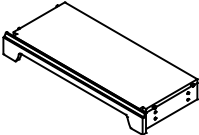
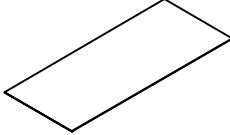
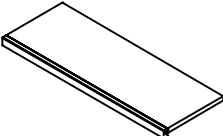
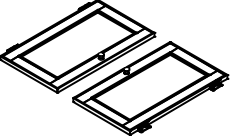
#### Step1:

Place the bottom panel (E), fixed shelf (D) and top (A) front facing down on a non abrasive surface.

Insert ①(4PCS) through the (E) to connect right side panel (B). Then insert ①(2PCS) through the fixed shelf (D) to connect the right side panel (B) and ①(2PCS) to connect the top (A) and the right side panel (B). do the same procedure to the left side panel (C).

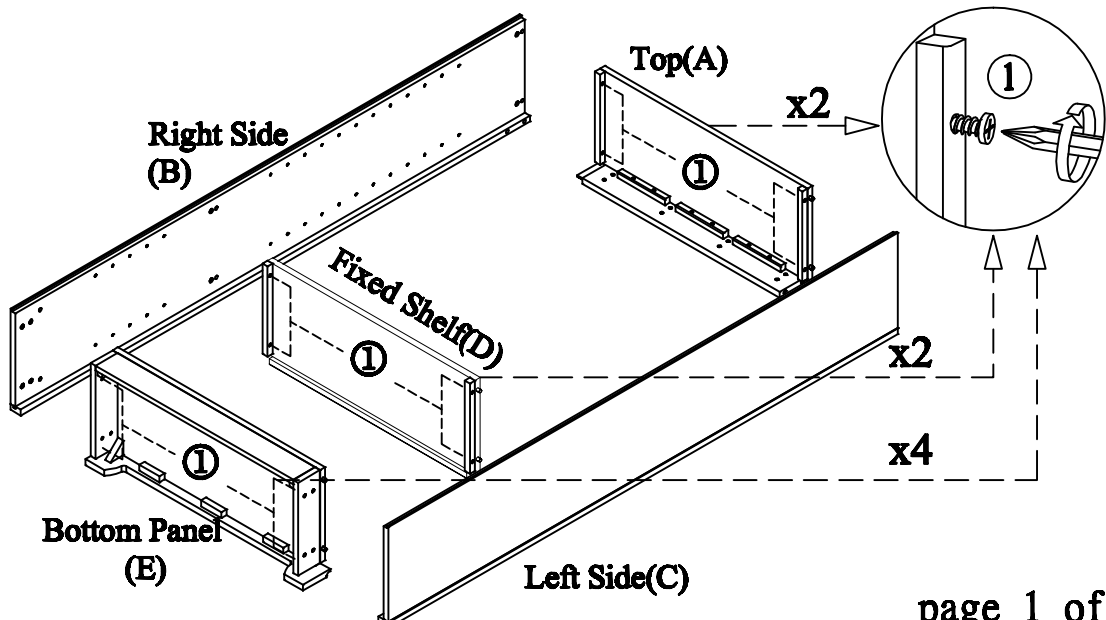

**Step 2:**

Place the back panel (F) over the bookcase. with finish facing down. once the back panel (F) is aligned insert 28 PCS through the predrilled holes to connect the bookcase.

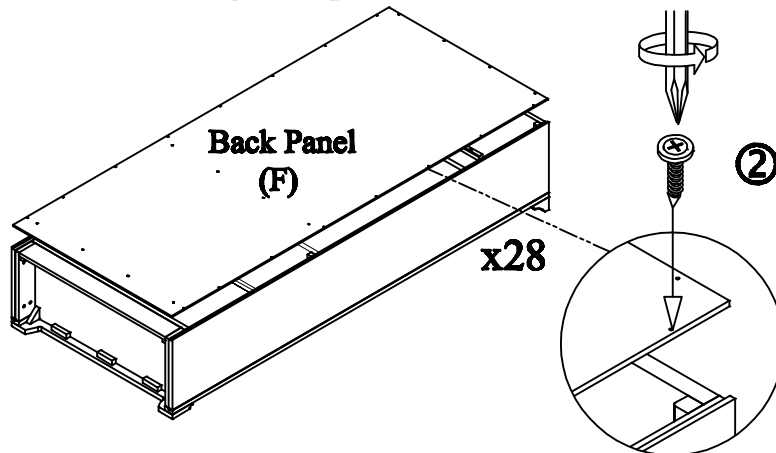

**Step 3.**

Locate the desired position of the shelves, insert shelf clips in corresponding holes. Place Adjustable shelves (G) on shelf clips and fasten with 3/4" sharp end screws using a phillips head screwdriver.

**Step 4.**

Attach the 2 hinges (3 holes on each hinge, 6 holes total) from the door (H) to the side panel by using 2PCS 5/8" sharp end screws, insert and tighten through hole A. Then insert and tighten 4PCS 5/8" sharp end screws through holes B.

**Caution:**For safety purpose please install the tip restraint kit.

**Note:**connecting plate goes here

