





WINNERS ONLY®

ASSEMBLY INSTRUCTIONS

PROD NO: BE1001QN2 / BG1001QN2 / BP1001QN2

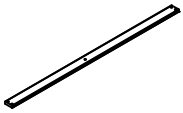
Component List :

(A) Headboard  1pc	(B) Footboard  1pc	(C) Side Rail  2pcs	(D) Slats  4 pcs	(E) Slat Support Leg  4 pcs
---	--	---	--	---

Hardware List :

(1) Screw #8*25mm  16 pcs
--

Caution: Please read instructions thoroughly before unpacking assembly parts. Sharp, exposed staple tips can cause injury, therefore, for your protection, please remove any exposed staples used in packing.

Please keep all hardware parts out of the reach of children.

1. We recommend that you should assemble this product with the assistance of another person; this will make assembly easier, and will help to eliminate damage to the product or injury to persons during assembly.
2. Be sure to check all packing materials carefully for small parts that may have come loose inside the carton during shipment.
3. Please do not over tighten screws or bolts.
4. Please put all parts on a non-abrasive floor before assembly, and follow the assembly steps to assemble your newly purchased product correctly and efficiently.

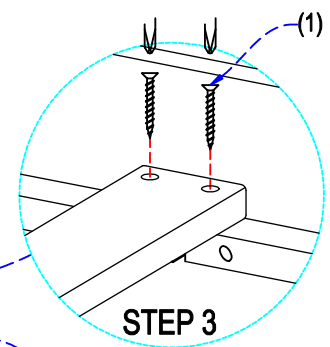
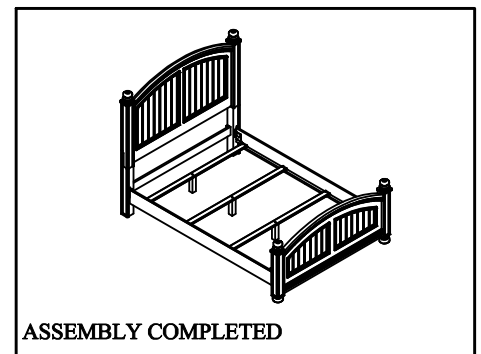
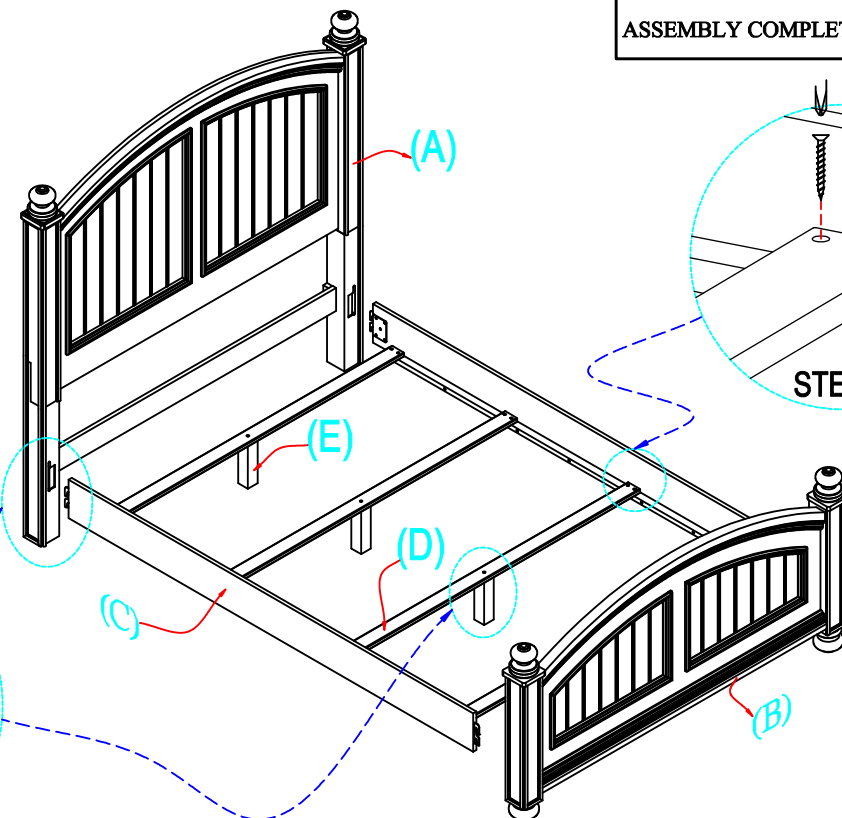
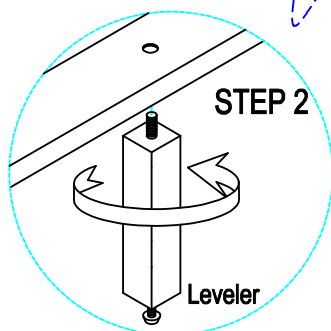
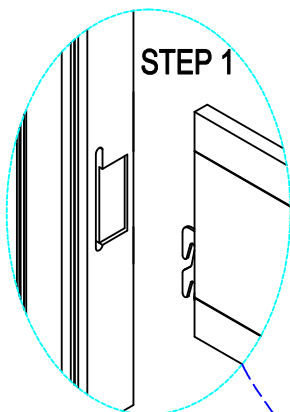



WINNERS ONLY®

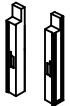

ASSEMBLY INSTRUCTIONS

PROD NO: BE1001FHN2/BE1001QHN2/BE1001KHN2/BE1001CKHN2
 BG1001FHN2/BG1001QHN2/BG1001KHN2/BG1001CKHN2
 BP1001FHN2/BP1001QHN2/BP1001KHN2/BP1001CKHN2

Component List :

<p>(A) Headboard Panel  1pc</p>	<p>(B) Headboard Legs L & R  2pcs</p>	<p>(C) Headboard Stretcher  1pc</p>
---	---	---

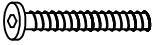
Hardware List :

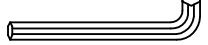
<p>① Long JCBC Bolt $\varnothing 5/16"$ x L44mm  10pcs</p>	<p>② Spring Washer $5/16"$($\varnothing 12$)*2mm  10pcs</p>	<p>③ Flat Washer $5/16"$($\varnothing 16$)*2mm  10pcs</p>	<p>④ Allen Key 4*59mm  1pc</p>
---	--	---	--

Caution: Please read instructions thoroughly before unpacking assembly parts. Sharp, exposed staple tips can cause injury, therefore, for your protection, please remove any exposed staples used in packing.

Please keep all hardware parts out of the reach of children.

1. We recommend that you should assemble this product with the assistance of another person; this will make assembly easier, and will help to eliminate damage to the product or injury to persons during assembly.
2. Be sure to check all packing materials carefully for small parts that may have come loose inside the carton during shipment.
3. Please do not over tighten screws or bolts.
4. Please put all parts on a non-abrasive floor before assembly, and follow the assembly steps to assemble your newly purchased product correctly and efficiently.

Step 1: Lay the Headboard Panel frontside down on a smooth and clean surface.

Step 2: Attach Left and Right Headboard Legs (B) to the Headboard Panel (A) using Long Bolt (1), Spring Washer (2), Flat Washer (3). Do not fully tighten yet.

Step 3: Attach Headboard Stretcher (C) to Left and Right Headboard Legs (B) using Long Bolt (1), Spring Washer (2), Flat Washer (3), tighten with Allen Key (4).

Step 4: Fully tighten all the bolts.

