







WINNERS

ONLY INC.

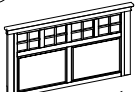
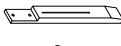

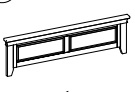
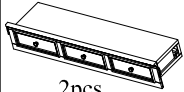

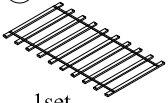

ASSEMBLY INSTRUCTIONS

ITEM NO : BR-DL1001KS(H,F,RS)
BR-DL1001QS(H,F,RS)

Component List:

(A) Headboard  1pc	(B) Headboard Legs  2pcs	(C) Cleats  2pcs	(D) Cross Bar  1pc	(E) Footboard  1pc	(F) Storage  2pcs	(G) Storage support leg  8pcs	(H) Slat Roll  1set	(I) Slat support legs  3pcs
---	--	--	--	--	--	---	---	---

Hardware List:

(1) Hex head Bolt Φ5/16"x2"  8pcs	(2) Hex head Bolt Φ5/16"x1-1/2"  4pcs	(3) Spring Washer Φ5/16"  12pcs	(4) Flat Washer Φ5/16"x19mm  12pcs	(5) Open end Wrench 12mm  1pc	(6) Screw Φ8x25mm  20pcs
--	--	--	--	--	---

Thank you for purchasing this quality product. Be sure to check all packing materials carefully for small parts which may have come loose inside the carton during shipment.

* Bunkie board is recommended to be used on top of the slats for better support of the mattress.

CAUTION: Two people are recommended for assembly.

Step 1: Attach legs (L/R) and cleats to the headboard using flat washer (4), spring washer (3) and bolts (1).

Step 2: Attach the cross bar (D) to the legs (B) using flat washer (4), spring washer (3) and bolts (2).

Step 3: Attach the storage support leg (G) to the storage (F).

Step 4: Attach storage (F) to the headboard (A) and footboard (E).

Step 5: Attach slat support leg (I) to slat roll (H)

Step 6: Secure slats in place using screw (6).

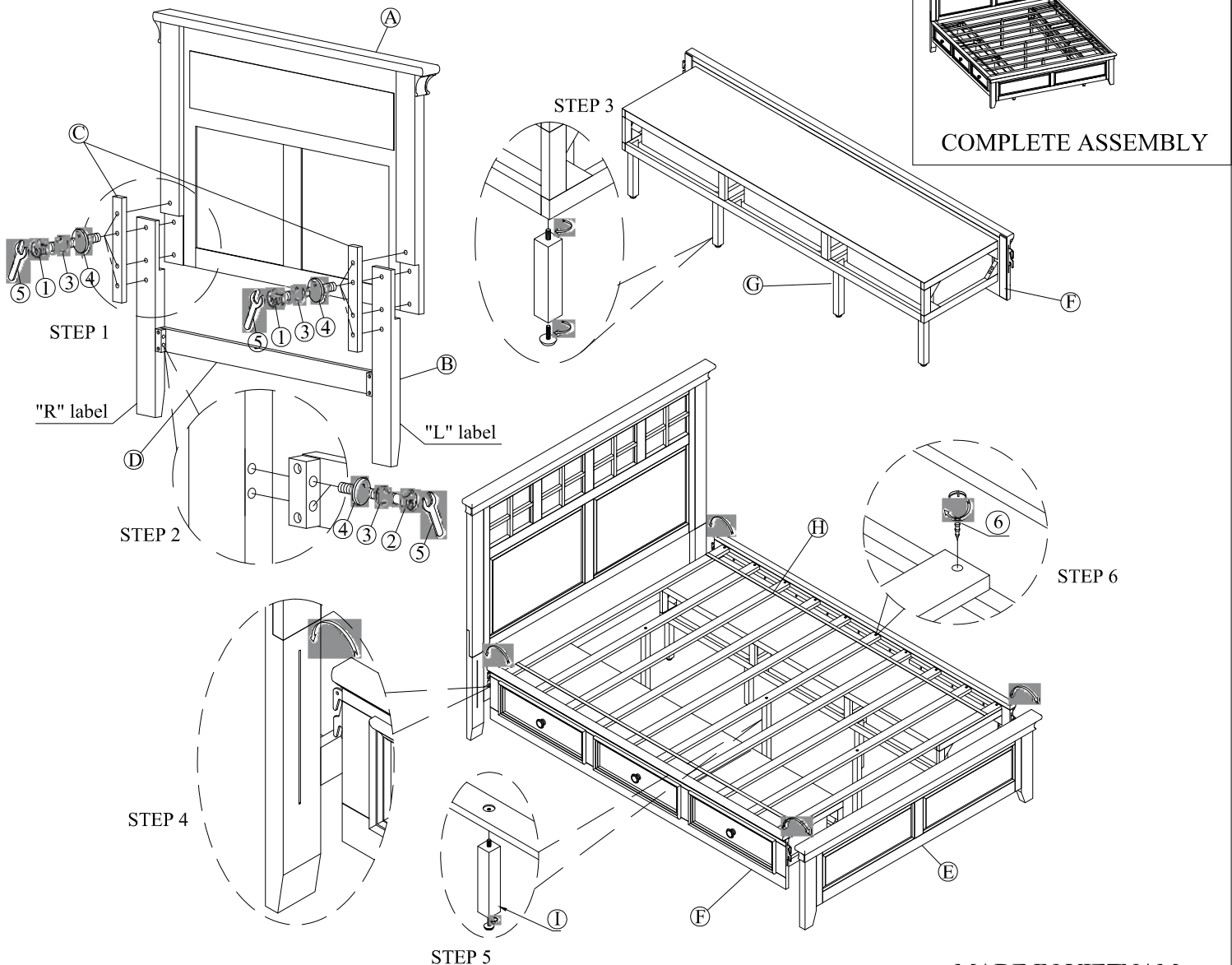

MADE IN VIETNAM