

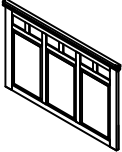

WINNERS ONLY®



ASSEMBLY INSTRUCTIONS

PROD NO.: **BMG1001QHS**

Component List :

(A) Headboard Panel  1pc	(B) Headboard Legs L  1pc	(C) Headboard Legs R  1pc
---	---	---

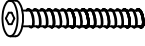
Hardware List :

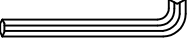
(1) Long JCBC Bolt $\phi 5/16" \times L44mm$  8pcs	(2) Spring Washer $5/16"(\phi 12) * 2mm$  8pcs	(3) Flat Washer $5/16"(\phi 19) * 2mm$  8pcs	(4) Allen Key $4 * 59mm$  1pc
---	---	---	--

Caution: Please read instructions thoroughly before unpacking assembly parts. Sharp, exposed staple tips can cause injury, therefore, for your protection, please remove any exposed staples used in packing.

Please keep all hardware parts out of the reach of children.

1. We recommend that you should assemble this product with the assistance of another person; this will make assembly easier, and will help to eliminate damage to the product or injury to persons during assembly.
2. Be sure to check all packing materials carefully for small parts that may have come loose inside the carton during shipment.
3. Please do not over tighten screws or bolts.
4. Please put all parts on a non-abrasive floor before assembly, and follow the assembly steps to assemble your newly purchased product correctly and efficiently.

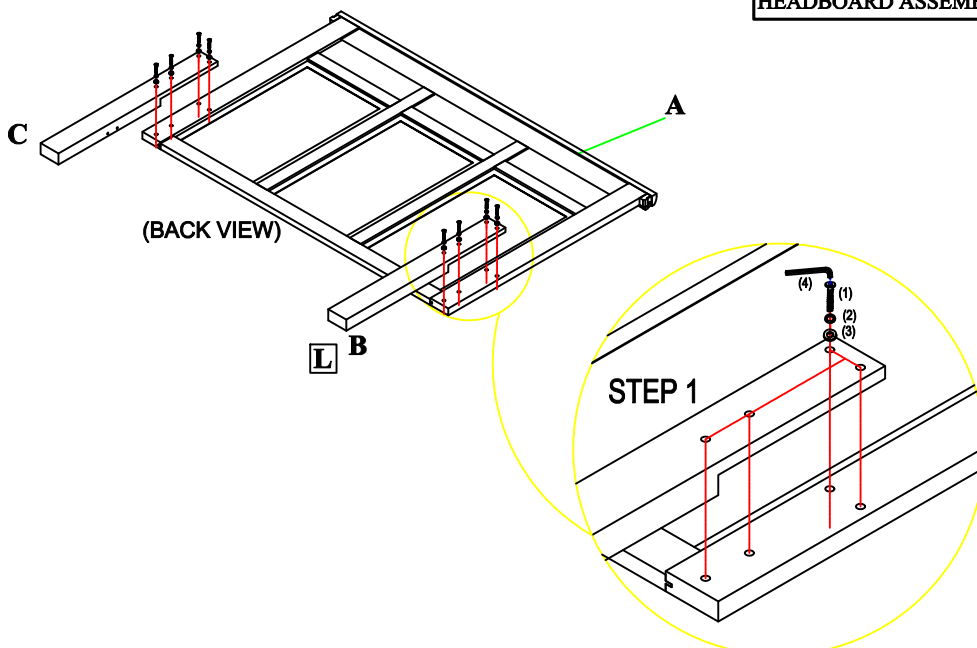
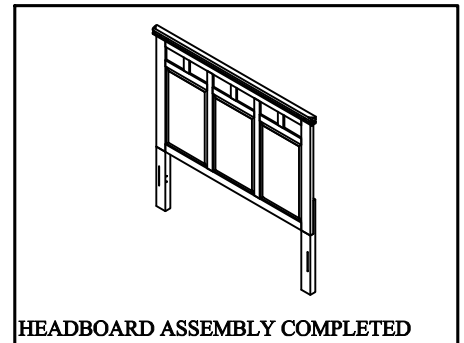



WINNERS ONLY®

ASSEMBLY INSTRUCTIONS

PROD NO.: BMG1001QHS / BMG1001QFS / BMG1001QRS

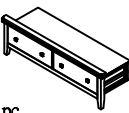
Component List :

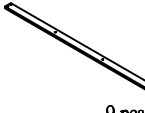
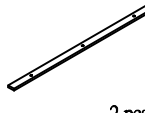
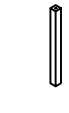
<p>(A) Headboard</p>  <p>1pc</p>	<p>(B) Footboard</p>  <p>1pc</p>	<p>(C) Side Rails</p>  <p>2 pcs</p>	<p>(D) Slats</p>  <p>9 pcs</p>	<p>(E) Slats Support Legs</p>  <p>2 pcs</p>	<p>(F) Slat Support Legs</p>  <p>6 pcs</p>
---	--	---	--	---	--

Hardware List :

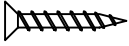
<p>(1) Screw #8*25mm</p>  <p>44 pcs</p>

Caution: Please read instructions thoroughly before unpacking assembly parts. Sharp, exposed staple tips can cause injury, therefore, for your protection, please remove any exposed staples used in packing.

Please keep all hardware parts out of the reach of children.

1. We recommend that you should assemble this product with the assistance of another person; this will make assembly easier, and will help to eliminate damage to the product or injury to persons during assembly.
2. Be sure to check all packing materials carefully for small parts that may have come loose inside the carton during shipment.
3. Please do not over tighten screws or bolts.
4. Please put all parts on a non-abrasive floor before assembly, and follow the assembly steps to assemble your newly purchased product correctly and efficiently.

Note : Bunkie board must be used to replace box spring

