



WINNERS ONLY[®]

ASSEMBLY INSTRUCTIONS





PROD.NO : BTB/BTG/BTH/BTP1009

Thank you for purchasing this quality product. be sure to check all packaging material carefully for small parts that may have come loose inside the carton during shipment.

Components List :

NO.	DESCRIPTION	Q' TY
A	 Dresser	1pc
B	 Mirror	1pc
C	 Support Bar	2pcs

Hardware list

NO.	SKETCH	DESCRIPTION	SIZE	Q'TY
1		Allen Bolt	1/4"*1-5/8"	8pcs
2		Lock Washer	8mm	8pcs
3		Flat Washer	8*19*2mm	8pcs
4		Allen Key	4*30*80mm	1pc

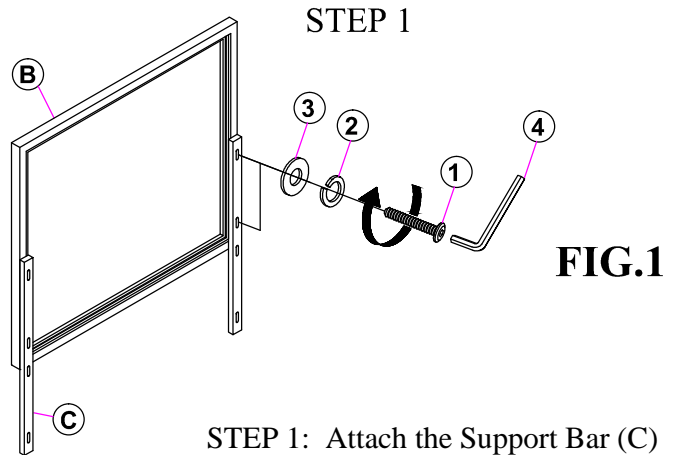

STEP 1: Attach the Support Bar (C) to the Mirror (B) using the provided hardware as shown on FIG.1

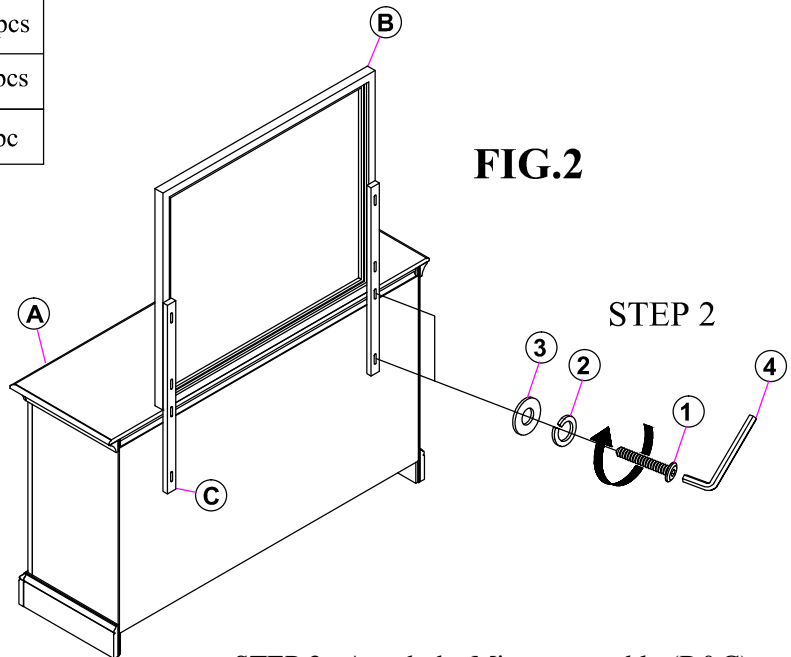

STEP 2: Attach the Mirror assembly (B&C) to Dresser (A) using the provided hardware as shown on FIG.2

Assembly is now completed.

