

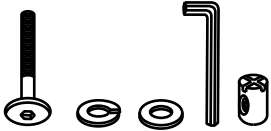





# Assembly Instructions

**C1-GL102S--O**  
**SPINDLE BACK WINDSOR SIDE CHAIR**

## PARTS LIST



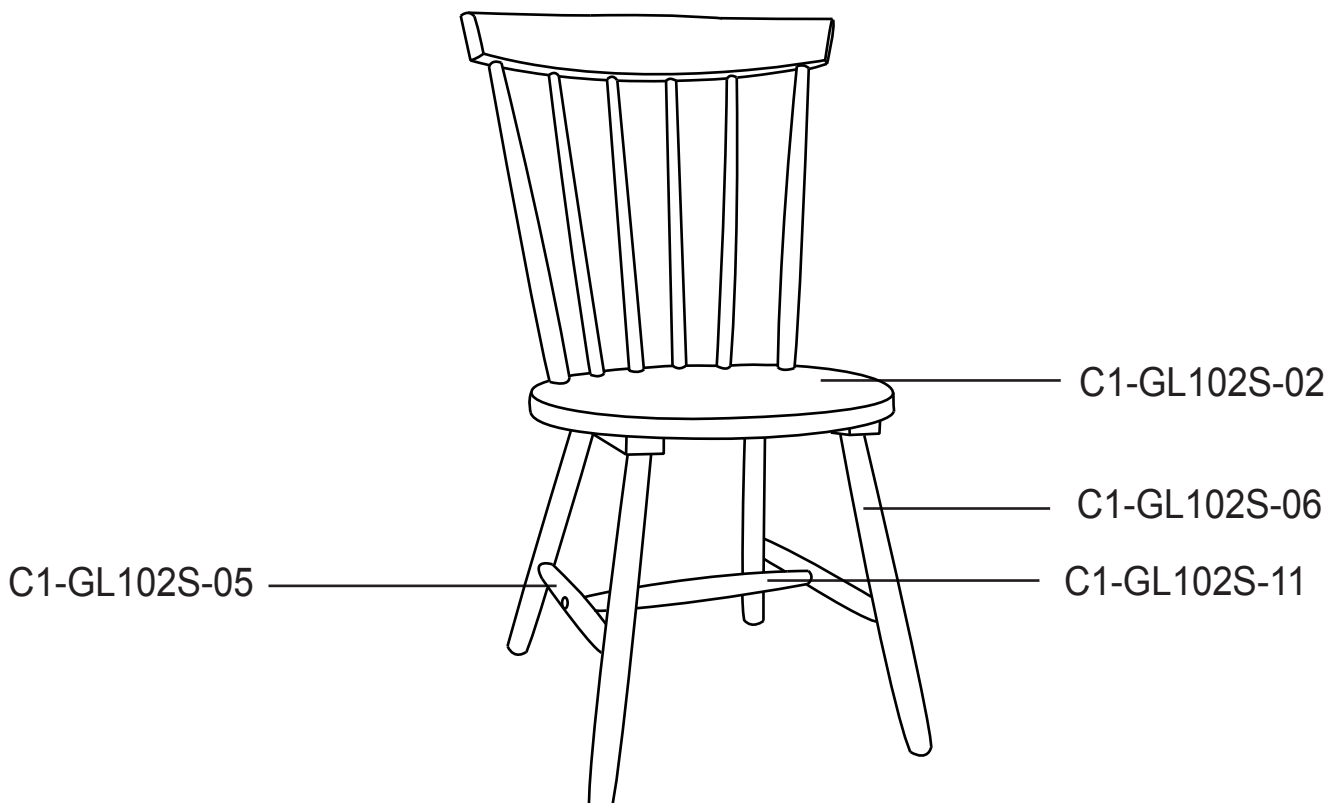



PART NO	FIGURE	DESCRIPTION	Q'TY
C1-GL102S-01		Hardware Bag	1 Pce
C1-GL102S-02		Chair Back	1 Pce
C1-GL102S-05		Right Leg Assembly	1 Pce
C1-GL102S-06		Left Leg Assembly	1 Pce
C1-GL102S-11		Center Stretcher	1 Pce
C1-GL102S-14		Wood Plugs	2 Pcs



# Assembly Instructions

## C1-GL102S--O SPINDLE BACK WINDSOR SIDE CHAIR

### HARDWARE PACK :

					
JCBC Bolt 8 pcs	Lock Washer 6 pcs	Flat Washer 6 pcs	Allen Key 1 pce	JRN Nut 2 pcs	Wood Plug 2 pcs

### ASSEMBLY :

1. Insert the centre stretcher into the side stretcher. Make sure its JRN Nut holes face downward. Insert a JRN Nut into the holes and position it with a screw driver (Not provided). Insert the JCBC Bolt through the side stretcher into the end of centre stretcher. Use the provided Allen Key. As shown in the Fig.1. Do not fully tighten yet.
2. Attach the chair leg assembly to the seat board by aligning the leg supporter as shown in the Fig.2.
3. Insert JCBC Bolt with Lock Washer and Flat Washer through the leg supporter into the seat board then tighten the bolt with the Allen Key. (But Do Not fully tighten the bolt yet.)
4. Turn the chair upright. Check its balance and tighten all bolts.
5. Insert Wood Plug into the holes at the middle of the stretcher.

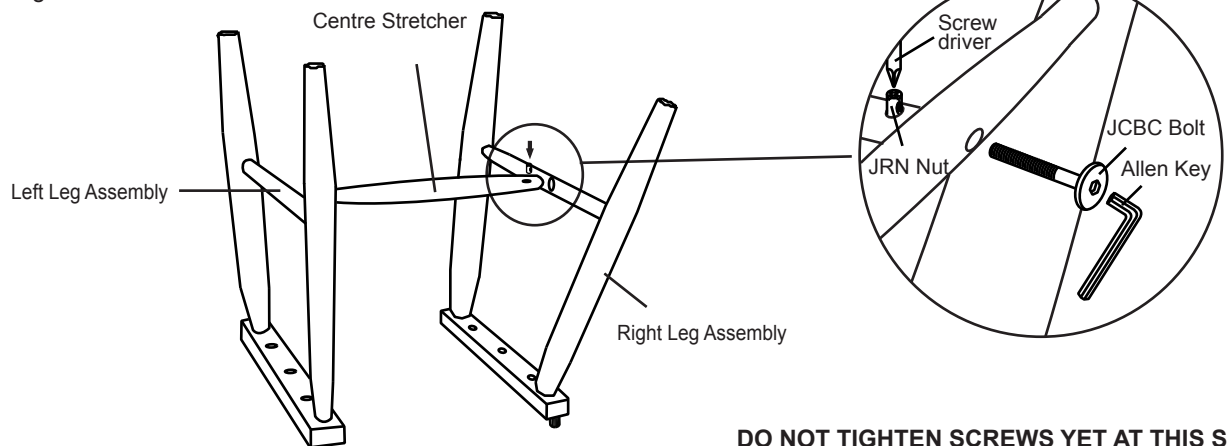

**DO NOT TIGHTEN SCREWS YET AT THIS STEP**

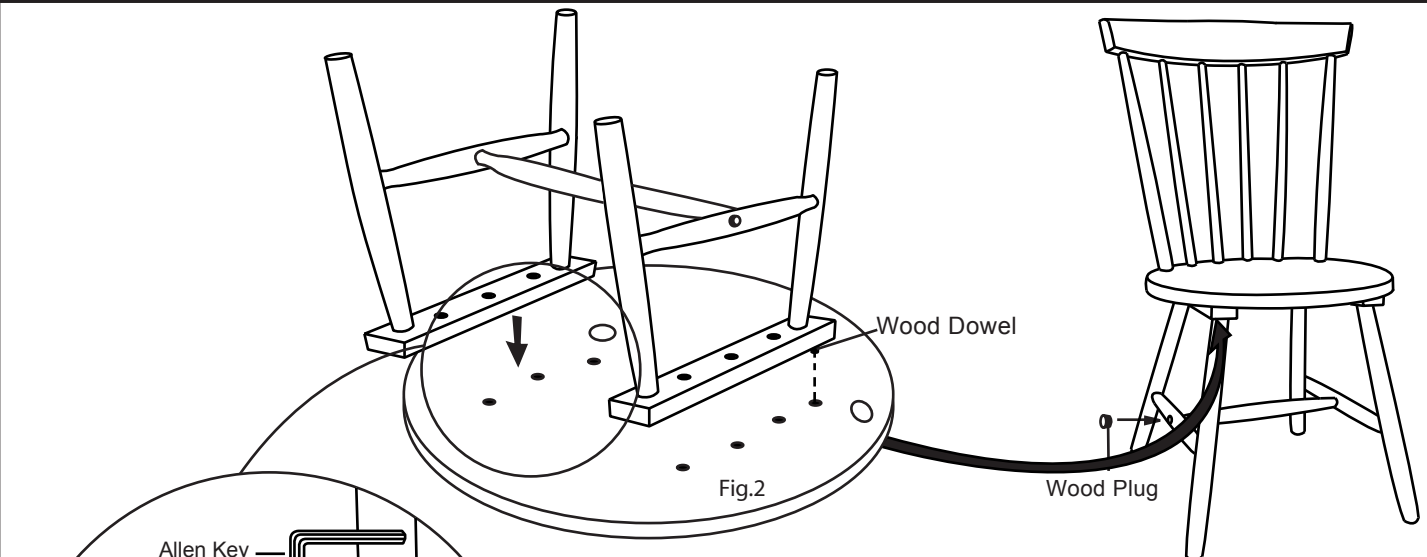

### IMPORTANT NOTE :

1. Use only the hardware supplied.
2. Do not over-tighten bolts.
3. This item may require periodic tightening.

### IMPORTANT NOTE :

~ Please keep all hardware out of the reach of children. Two or more people are needed for assembly.

### CARE INSTRUCTION

- ~ Be sure to use the same type of polish consistently. Your furniture will appear cloudy or streaky if oil based or wax based polishes are interchanged.
- ~ Spray your furniture surface evenly. Wipe in a circular motion with a soft clean cloth.