

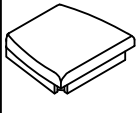

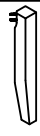

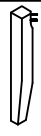

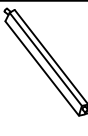





Assembly Instructions

“ X “ Back Side Chair C1-T451S-C / C1-T451S-O

Caution: Please read instructions thoroughly before unpacking assembly parts. Sharp, exposed staple tips can cause injury, therefore, for your protection, please remove any exposed staples used in packing.

1. We recommend that you should assemble this product with the assistance of another person; this will make assembly easier, and will help to eliminate damages to the product or injury to persons during assembly.
2. Be sure to check all packing materials carefully for small parts that may have come loose inside the carton during shipment.
3. Please do not over tighten screws or bolts.
4. Please put all parts on a non-abrasive floor before assembly, and follow the assembly steps to assemble your newly purchased product correctly and efficiently.

PARTS LIST					
					
(A)	(B)	(C) 1(Left)	(D) 1(Right)	(E) 1(Left)	(F) 1(Right)

No	HARDWARE LIST	Q'TY
1	 SMALL FLAT WASHER □ 1/4"	6
2	 SMALL SPRING WASHER □ 1/4"	6
3	 LARGE FLAT WASHER □ 5/16"	4
4	 LARGE SPRING WASHER □ 5/16"	4
5	 BOLT □ 1/4" x 2-3/4"L	4
6	 BOLT □ 1/4 x 1-5/8"L	2
7	 NUT	4
8	 SCREWS	4
9	 HEX KEY	1
10	 WRENCH	1

Step 1. Unpack carton and place all parts on a non-abrasive floor.

Step 2. Remove plastic cover from upholstered seat cushion (B)

Step 3. Attach the chair back frame (A) to the Upholstered seat frame(B) by using flat washers (1), spring washers (2) and bolts (6). Hand tighten bolts.

Attach the chair back frame (A) to the Upholstered seat frame (B) by using flat washers (1), spring washers (2) and bolts (5) through the pre-drilled holes in the rear corner blocks of the wood seat frame and into the chair back frame (A).

STEP 3

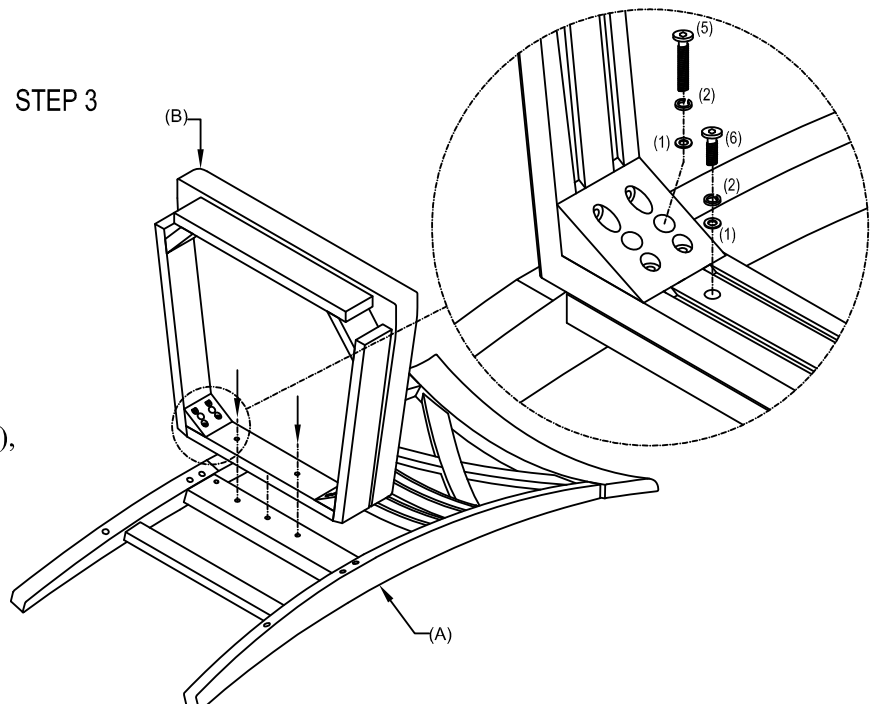

This step requires installation of six bolts

Assembly Instructions

“ X “ Back Side Chair C1-T451S-C / C1-T451S-O

Step 4. Attach front legs (C)&(D) to the corner blocks of the wood seat frame (B) by using flat washers (3), spring washers (4) and nuts (7) through the pre-drilled holes in the front corner blocks of the wood seat frame. Then hand tightens all nuts securely. Attach side stretcher Right (F) and Left (E) into pre-drilled holes in front leg (C) &(D) and chair back frame (A) by using screw (8). Hand tighten all screws securely.

Step 5. Securely tighten bolts (5), (6) and nuts (7) by using Hex key (9) & wrench (10).

ASSEMBLY INSTRUCTIONS SUPPLEMENT

Most floors have slight irregularities that can affect chair leveling. If your chair is uneven when placed in its desired location, perform the following steps:

- Step 1. Loosen front legs.
- Step 2. Extend both front legs downward to their fullest length.
- Step 3. Gently push downward on the front of seat until all four legs rest on floor.
- Step 4. Once the chair is level tighten all nuts.

STEP 4

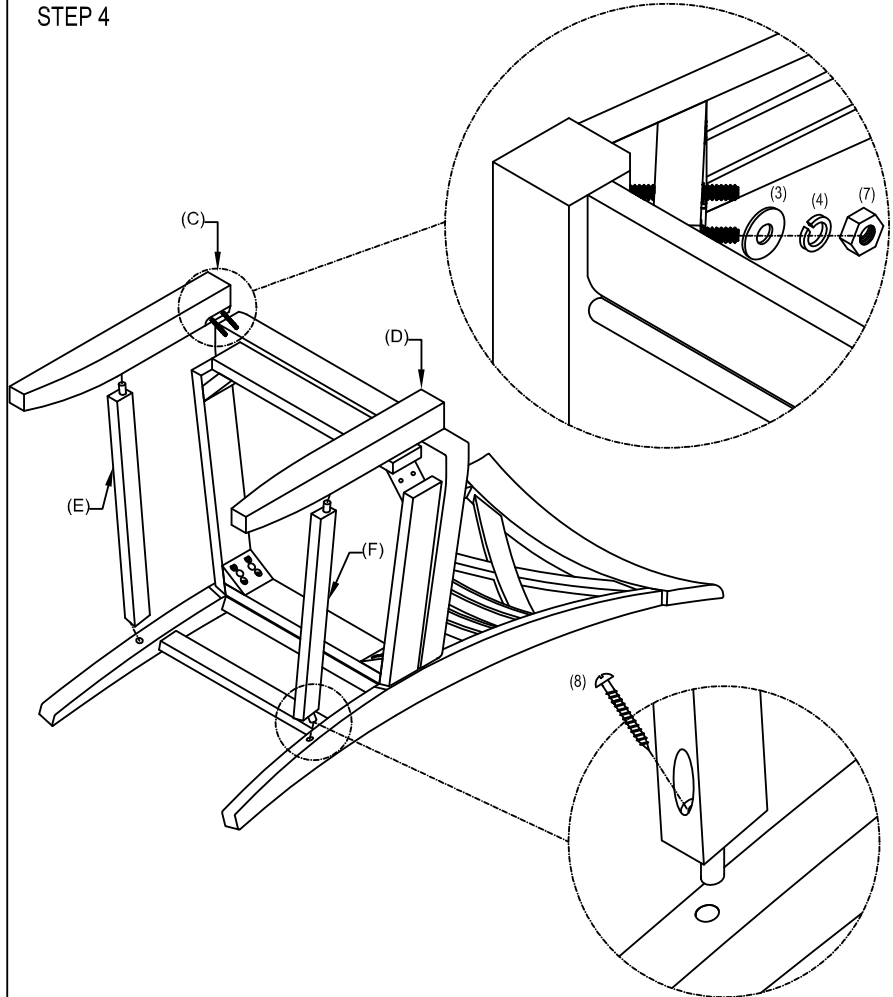

This step requires installation of four nuts and four screws

