

Reminders

1. Two people are needed for assembly.
2. Use only the hardware supplied.
3. Do not over-tighten bolts.
4. This item may require periodic tightening.

WINNERS ONLY INC.

ASSEMBLY INSTRUCTIONS

ITEM NO: E1-SN154 - -G
E1-SN154 - -X

IMPORTANT NOTE:

Please keep all hardware parts out of the reach of children.

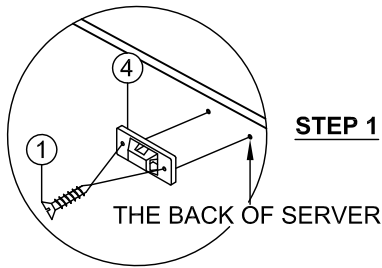
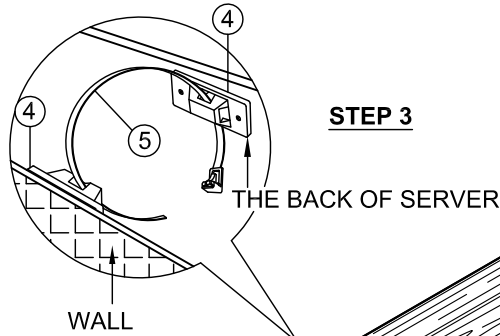
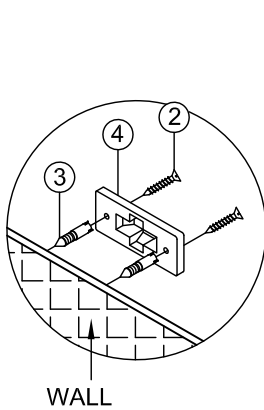

TO INSTALL THE SAFETY WALL STRAP

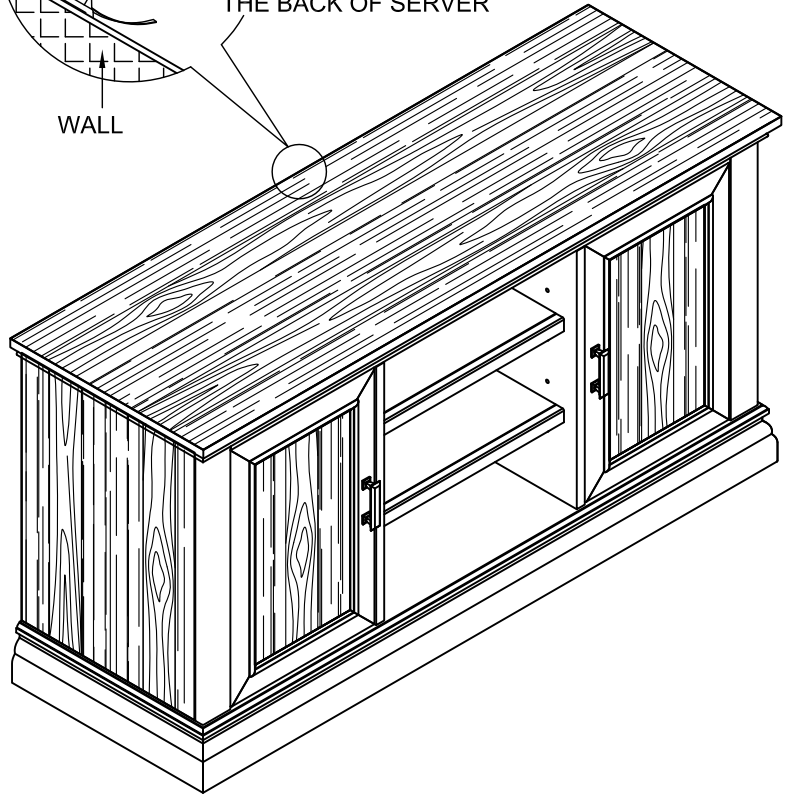

Thank you for purchasing this quality product. Be sure to check all packing material carefully for small parts that may have come loose inside the carton during shipment.

1 OF 2

MADE IN VIETNAM

① Screw
($\phi 7^* \phi 3.5^* 16$)

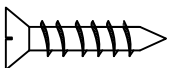

2 PCS

② Screw
($\phi 7^* \phi 3.5^* 25$)

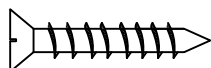

2 PCS

③ Wall Mounts



2 PCS

④ Mounting Plates

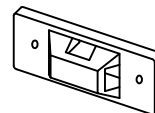





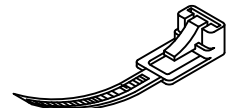

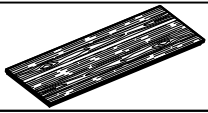

2 PCS

⑤ Secure Band

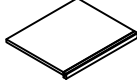
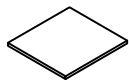
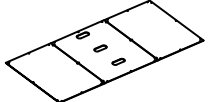

1 PC

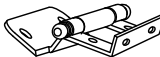
Components List

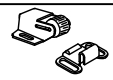
PART NO	FIGURE	DESCRIPTION	QTY
A		Top Panel	1pc
B		Wood Door	2pcs
C		Wood Middle Shelf	2pcs
D		Wood Side Shelf	2pcs
E		Back panel	1pc
F		Handle	2pcs
G		Bolt (5/32" x 25mm)	4pcs
H		Plastic Glide	4pcs
I		Side Door Hinge	4pcs
J		Shelf Supporter	16pcs
K		Door Catch	2pcs

