



# Assembly Instruction

53661

## SOLID TOP BUTTERFLY RECTANGULAR TABLE

### HARDWARE PART:

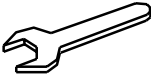
 NUT 8 pcs	 LOCK WASHER 8 pcs	 FLAT WASHER 8 pcs	 WRENCH 1 pc
---	---	---	---

NOTE: THE UNIT SHOULD BE ASSEMBLED BY 2 OR MORE PEOPLE.

### STEP 1

TURN THE TABLE TOP UPSIDE DOWN ON A PROTECTIVE SURFACE SUCH AS CARPET OR OTHER SOFT MATERIAL. PLACE THE LEG TO THE CORNER OF THE APRON, AND TIGHTEN THE **FLAT WASHER**, **LOCK WASHER** AND **NUT** USING THE **WRENCH** PROVIDED. REPEAT FOR EACH LEG.

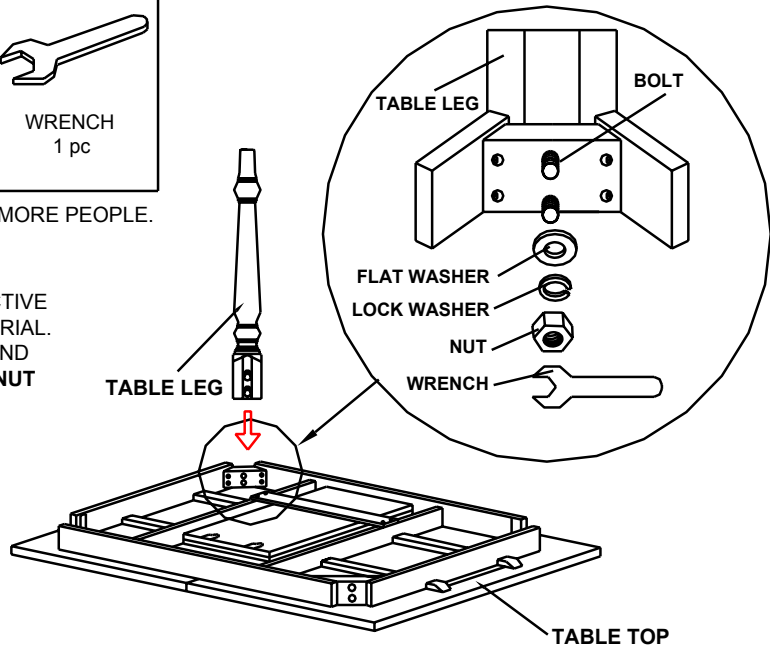

### STEP 2

UNLOCK THE HOOKS UNDERNEATH THE TABLE AND PULL THE TABLE TOP WIDE OPEN EQUALLY FROM BOTH ENDS. LIFT BOTH LEAVES FROM THE COMPARTMENT.

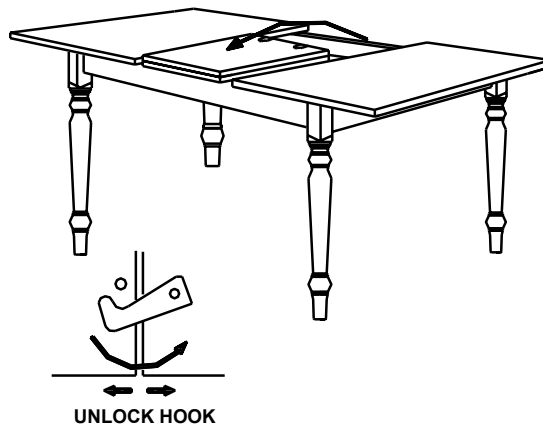

### STEP 3

PLACE THE LEAF ON THE TOP SURFACE CAREFULLY AND PUSH TABLE TOP FROM BOTH ENDS TO CLOSE GAP AND LOCK THE HOOKS UNDERNEATH THE TABLE.

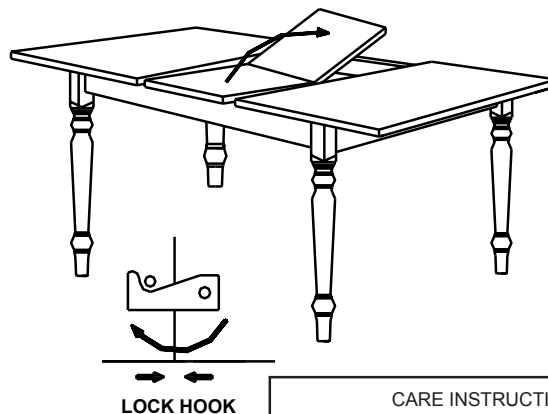

### CARE INSTRUCTION







- ~ Be sure to use the same type of polish consistently. Your furniture will appear cloudy or streaky if oil based or wax based polishes are interchanged.
- ~ Spray your furniture surface evenly. Wipe in a circular motion with a soft clean cloth.

# Assembly Instruction

53661

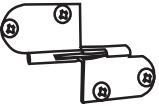
SOLID TOP BUTTERFLY RECTANGULAR TABLE

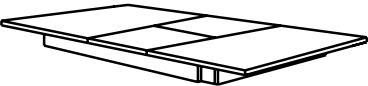
## PARTS LIST

PART NO.	FIGURE	DESCRIPTION	QTY
53661-01		HARDWARE BAG	1 Pc
53661-05		<b>GLIDES (SLIDE)</b>	2 Pcs
53661-07		LEG	4 Pcs
53661-09		<b>LEAF HINGE</b>	2 Pcs
53661-10		<b>LOCK</b>	4 Pcs
53661-12		<b>SUPPORT LEAF HINGE</b>	2 Pcs
53661-13		TABLE TOP	1 Pc
53661-17		<b>SUPPORT LEAF</b>	1 Pc

