

IMPORTANT NOTICE:
Storing and opening the leaf requires 2 people.

WINNERS ONLY®

ASSEMBLY INSTRUCTIONS

PROD. NO : T1-TO4078 - -P

Thank you for purchasing this quality product. Please read the instructions thoroughly before unpacking the assembly parts.

Caution: sharp exposed staple tips can cause injury, therefore for your protection, please remove any exposed staples used in packing.

Please keep all hardware parts out of the reach of children.

1. We recommend that you should assemble this product with the assistance of another person; this will make the assembly easier, and will help to prevent personal injury and to insure parts are not damaged during the assembly process.







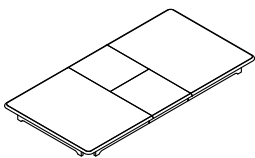

2. Before beginning, please check the packing materials carefully for small parts which may have come loose inside the carton during shipping. Please do not discard any packing material until all parts have been located. If any parts are missing, please contact your dealer for prompt replacement.

3. To prevent damage to your floor or carpet, please check the bottom of each piece of furniture for stain residues and rough surfaces and also check for staples or nails left after removing the packing materials. The manufacturer will not be held responsible if preventive steps are not taken prior to installation.

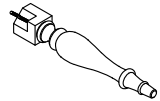
4. Please do not over tighten screws or bolts. During normal use everyday, screws, bolts, nuts and wooden plugs may loosen up. They should be periodically inspected and re-tightened to prevent damage to the furniture and (or) personal property or cause injury. Always check to be sure all hardware on this list and the below mentioned components are attached to the furniture properly and kept tightened.

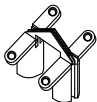
5. Please lay all parts and hardware on a non abrasive surface such as a carpet, and follow the assembly

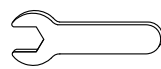
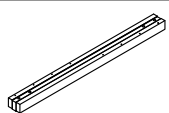
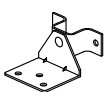
Hardware List :

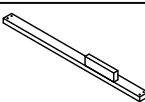
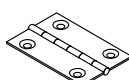
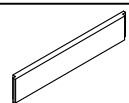
COMPONENTS LIST			QTY	NO	DESCRIPTION	SIZE	FIGURE	QTY
A	Table Top		1pc	1	Flat Washer	Ø5/16"x 19mm		8pcs
B	Table Leg		4pcs	2	Spring Washer	Ø5/16"x 12mm		8pcs
C	Leaf Hinge		2pcs	3	Hex- Nut	Ø5/16"x 12mm		8pcs
D	Clamp Lock		4pcs	4	Allen Wrench	12x 75 mm		1pc
E	Wood Glide		2pcs	<p>IMPORTANT NOTE:</p> <ul style="list-style-type: none"> - Please keep all hardware parts out of the reach of children. - Two or more people are needed for assembly. <p>TIP: store the Allen key and or Wrench used in assembly in this product's drawer or use masking or painter's tape to affix it to the underside of the product. This will make it easier to find if you want to periodically tighten bolts or disassemble the product.</p>				
F	Support Leaf Hinge		2pcs					
G	Plastic Glide		4pcs					
H	Support Bar (Left- Right)		2pcs					
I	Apron Hinge		4pcs					
J	Apron Leaf (Left- Right)		2pcs					

WINNERS ONLY®

ASSEMBLY INSTRUCTIONS

STEP 1:

Turn Table Top (A) upside down on a soft protective surface such as a carpet. Attach Table Legs (B) to Table Top (A). Using Flat Washer (1), Spring Washer (2) and Hex Nut (3) tighten and secure using Allen Wrench(4).

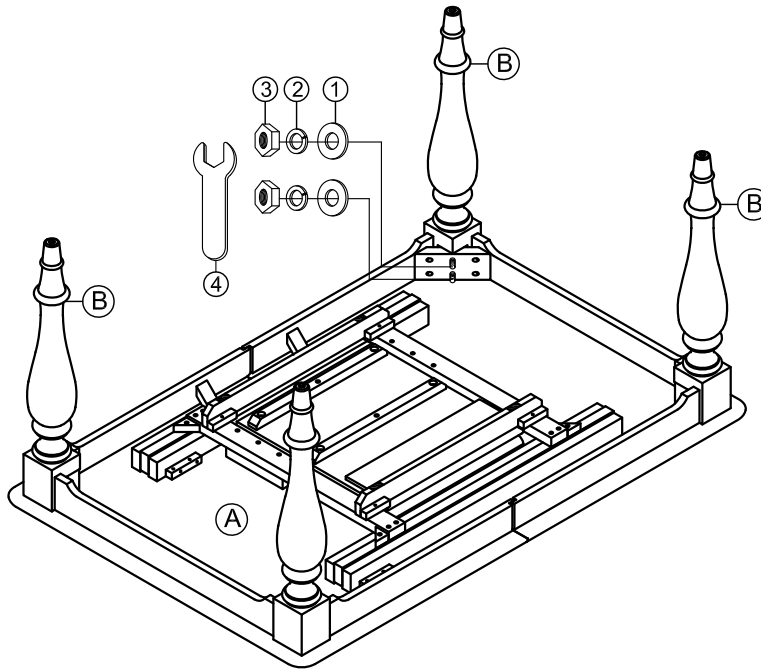

STEP 2:

Please remove wood blocks before use.

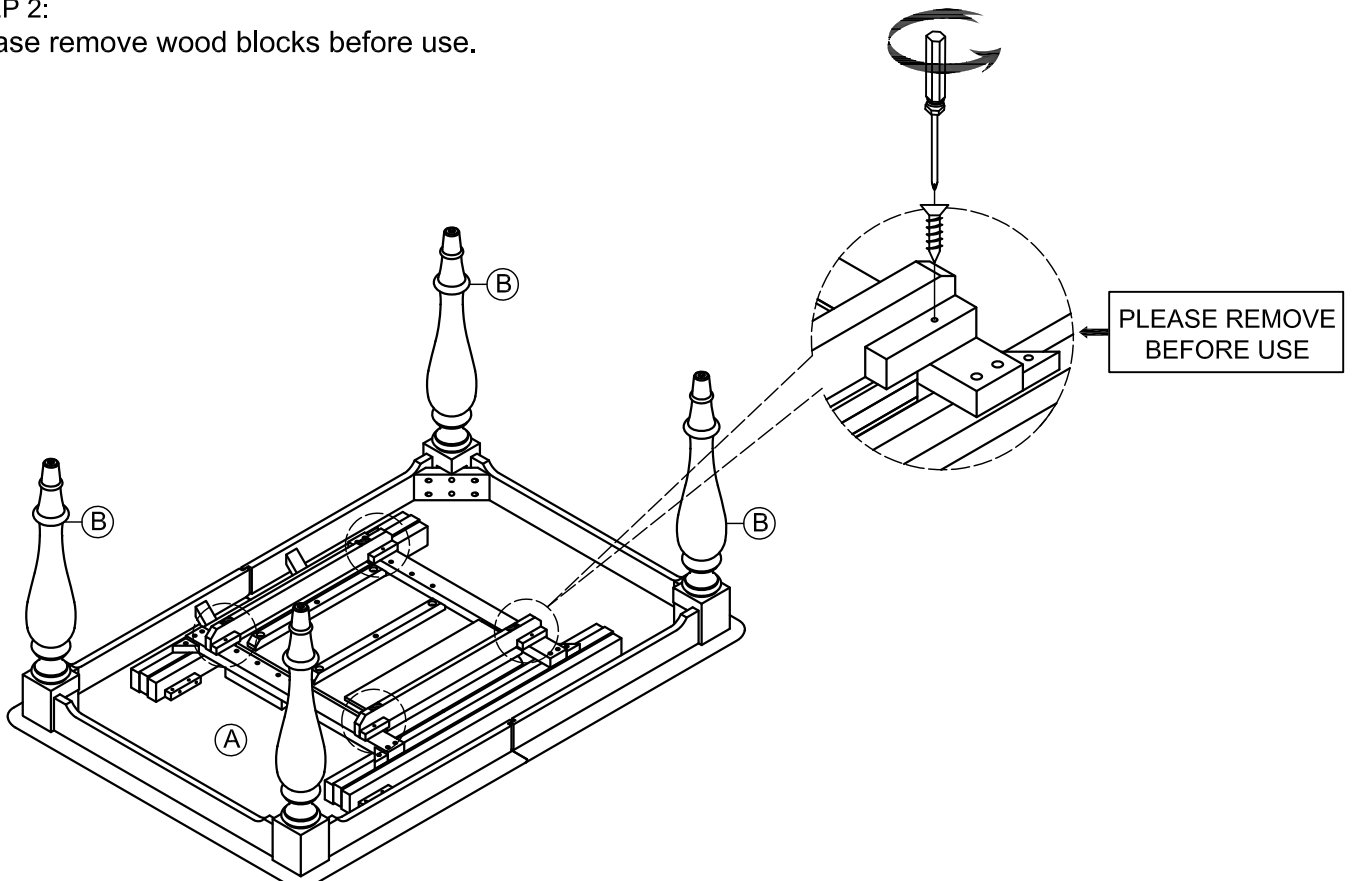

WINNERS ONLY®

ASSEMBLY INSTRUCTIONS

STEP 3:

- Turn the table to the upright position.
- Pull the Table Top (A) from both ends and open the table leaf which is stored underneath the table top.
- Close the table top by pushing from both ends and clamp lock the latch underneath the table top to prevent injury or the product from becoming damaged from Table top sliding.

