

WINNERS ONLY®







ASSEMBLY INSTRUCTIONS

Reminders

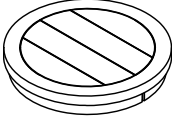
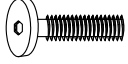
1. Use only the hardware supplied.
2. Do not over-tighten bolts.
3. This item may require periodic tightening.

PROD. NO : T2-SN101E - -G
T2-SN101E - -X

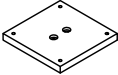
Hardware List :

COMPONENTS LIST			QTY	NO	DESCRIPTION	SIZE	SKETCH	QTY
A	Table Top		1pc	1	Long Bolt	Ø1/4"x 45mm		8pcs
B	Table Post		1pc	2	Spring Washer	Ø5/16"x 12mm		8pcs
C	Bottom Shelf		1pc	3	Flat Washer	Ø5/16"x 19mm		8pcs
D	Mounting Plate		1pc	4	Allen Key	58x 23x 4mm		1pc

STEP 1:

Attach Table Post (B) to the Mounting Plate (D), using long bolt (1) spring washer (2), flat washer (3), tighten with allen key (4).

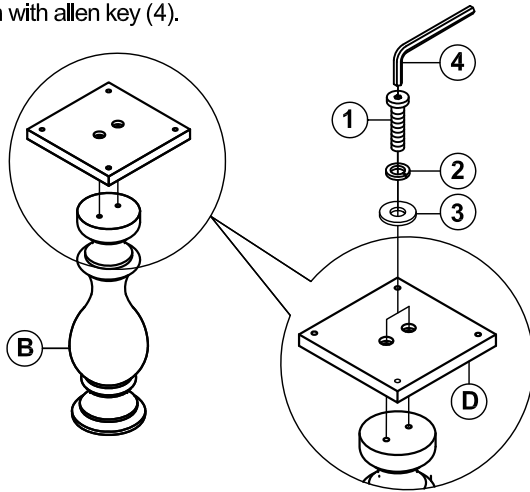

STEP 2:

Turn Table Top (A) upside down on a soft protective surface such as a carpet. Attach Table Top (A) to the Mounting Plate (D), using long bolt (1), spring washer (2), flat washer (3), tighten with allen key (4).

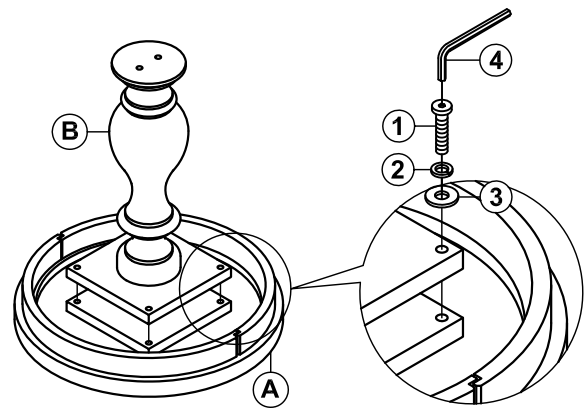

STEP 3:

Attach Bottom Shelf (C) to the Table Post (B), using long bolt (1), spring washer (2), flat washer (3), tighten with allen key (4).

NOTE: Please make sure the wood pattern of the Bottom Shelf (C) is in the same direction of the Table Top (B) wood pattern.

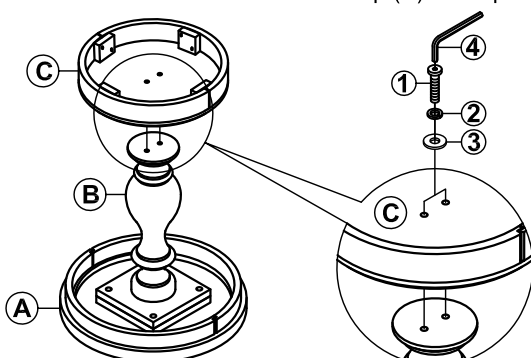

STEP 4:

Assembly is now complete, thank you for your purchase.

